

Table of Content

1. GENERAL INFORMATION	1
1.1 Overall View	1
1.2 Display Panel	1
1.3 Key Panel	1
1.4 Features	3
1.5 Specifications	3
1.5.3 Dimensions	4
1.6 Key Functions	5
1.7 Indicators	7
2. SETUP	8
2.1 Mode Change	8
2.2 Specification Setting	9
2.2.1 Specification Entry(141)	9
2.2.2 Specification List	10
2.3 Password Setting	35
2.3.1 Procedures of Password Setting	35
2.3.2 Password Using	36
2.4 Clear Files	37
3. PROGRAM MODE	38
3.1 Programmable Files	38
3.2 General Explanation	39
3.3 Department Files	40
3.3.1 Program Department File	40
3.3.2 Delete Department File	41
3.4 Main Group Files	42
3.4.1 Program Main Group File	42
3.4.2 Delete Main Group File	43
3.5 Program / Skip Item Data	44
3.6 PLU Programming	46
3.6.1 Program PLU File(weighing item)	50
3.6.2 Program PLU File(non-weighing item)	53
3.6.3 PLU [COPY] Function	57
3.6.4 Delete PLU File	58
3.6.5 Volume Discount & Mark Down print function	59
3.7 Memory Status	61
3.8 Key Assignment	62
3.8.1 PLU Assignment	62

3.8.2 Function Key Assignment	62
3.8.3 Delete Preset Key Assignment.....	63
3.9 Shop Name File	64
3.9.1 Program Shop Name File.....	64
3.9.2 Delete Shop Name File	65
3.10 Advertisement File	66
3.10.1 Program Advertisement File	66
3.10.2 Delete Advertisement File	67
3.11 Vender File.....	68
3.11.1 Program Vender File.....	68
3.12 Program Date And Time	69
3.13 Special Message File.....	70
3.13.1 Program Special Message File.....	70
3.13.2 Delete Special Message File.....	71
3.14 Ingredient File.....	72
3.14.1 Program Ingredient File.....	72
3.14.2 Delete Ingredient File.....	73
3.15 Text File.....	74
3.15.1 Program Text File	74
3.15.2 Delete Text File	75
3.16 Free Format File.....	76
3.16.1 General Information	76
3.16.2 Print Area, Print Position and Print Angles.....	77
3.16.3 Programming Parameter Of Print Items	79
3.16.4 Free Format Entry	81
3.16.5 Free Format Copy Function.....	86
3.16.6 Free Format Delete Function	86
3.16.7 Sample of program a format by modifying the existing format	87
3.17 Place File.....	90
3.17.1 Program Place File.....	90
3.17.2 Delete Place File.....	90
3.18 Machine Setting	91
3.19 Logo File.....	92
3.19.1 Pre-programming Logo Data.....	92
3.19.2 Program Display & Keys Function	93
3.19.3 Programming Order	94
3.19.4 Program Logo File.....	94
3.19.5 Delete Logo File.....	95
3.20 Tax File	96
3.20.1 Program Tax File.....	96
3.20.2 Delete Tax File.....	97
3.21 Scroll Message File.....	98

3.21.1 Program Scroll Message File	98
3.21.2 Delete Scroll Message File	98
3.22 Scroll Sequence File	99
3.22.1 Program Scroll Sequence File	99
3.22.2 Enable or Disable Scroll Sequence File	100
3.22.3 Delete Scroll Sequence Number	101
3.23 ASCII Character Input Method	102
3.24 ASCII Code Input Method	103
4. REGISTRATION MODE.....	104
4.1 ON/OFF	104
4.2 Reset and Weighing Check	104
4.3 Tare Subtraction	105
4.3.1 One touch Tare Subtraction	105
4.3.2 Digital tare Subtraction	105
4.4 PLU Call Up	106
4.4.1 Manual PLU Call Up	106
4.4.2 PLU Call Up by Preset Key	106
4.4.3 PLU Call by Numeric Key (Auto PLU Call)	106
4.5 Fix Operation	107
4.5.1 Fix Tare by FIX Key	107
4.5.2 Fix PLU by FIX Key	107
4.5.3 Fix Unit Price by FIX Key	107
4.6 Operation Mode Change	108
4.7 Item Label Printing in Manual Mode	109
4.7.1 Label Printing for PLU Item	109
4.7.2 Label Printing for NON-PLU Item	110
4.8 Total Label Printing in Manual Mode	111
4.8.1 Sales Transaction	111
4.8.2 [PRICE DISCOUNT] Function Key in Add Mode	112
4.8.3 [PRICE % DISCOUNT] Function Key in Add Mode	112
4.9 Data Correction	113
4.9.1 On The Spot Correction	113
4.9.2 Void by Item Correction	114
4.10 Item Label Printing in Pre-pack Mode	115
4.10.1 Item Label Issue for PLU Item	115
4.10.2 Item Label Issue for NON-PLU Item	116
5. READ REPORT MODE.....	117
5.1 Report Factor Select	117
5.2 Report Type Selection	117
5.2.1 Main Group Report	119
5.2.2 PLU Report	119

5.2.3 Department Report.....	120
5.2.4 Sales Report.....	121
5.2.5 24Hour Report	121
5.2.6 ABC Report.....	121
5.2.7 Clerk Report.....	122
5.2.8 Pre-pack Report.....	123
5.2.9 Tax Report.....	124
5.2.10 Store Summarized Report.....	124
6. RESET REPORT MODE.....	125
6.1. Reset Report.....	125
6.1.1 Sales Daily / Monthly/Term Reset Report.....	125

1. GENERAL INFORMATION

1.1 Overall View

- Bench Type

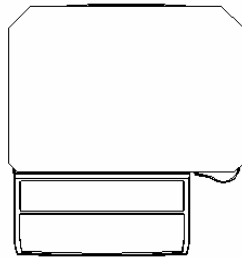
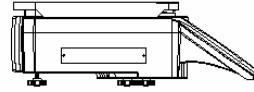
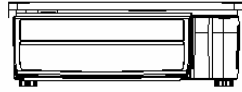

- Pole Type

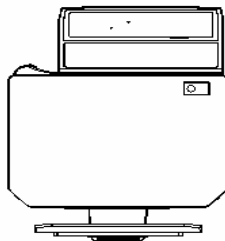
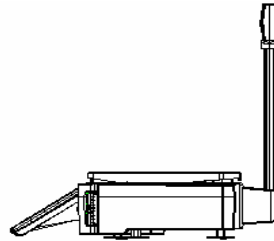
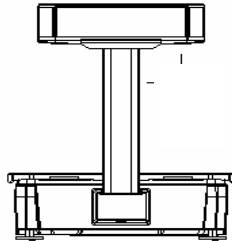

- Elevated Type

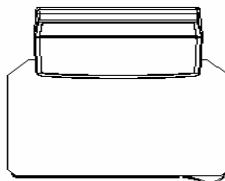
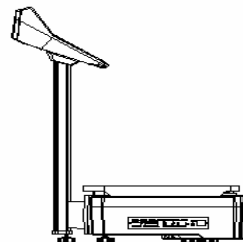
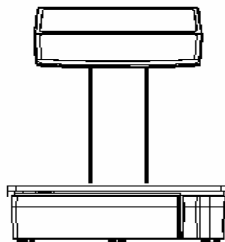

- Bench-CS Type

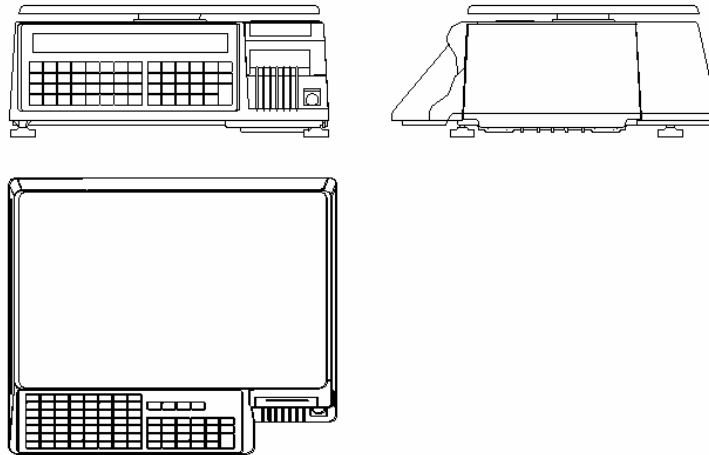

- Pole-CS Type

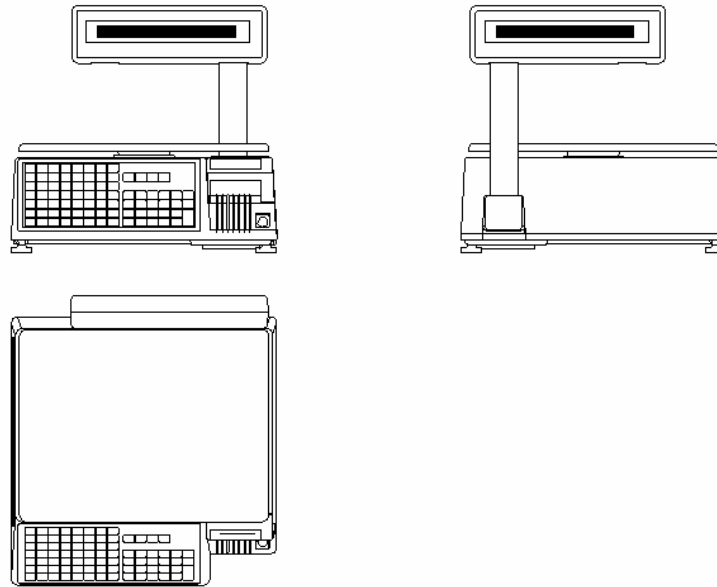

- Hand Type

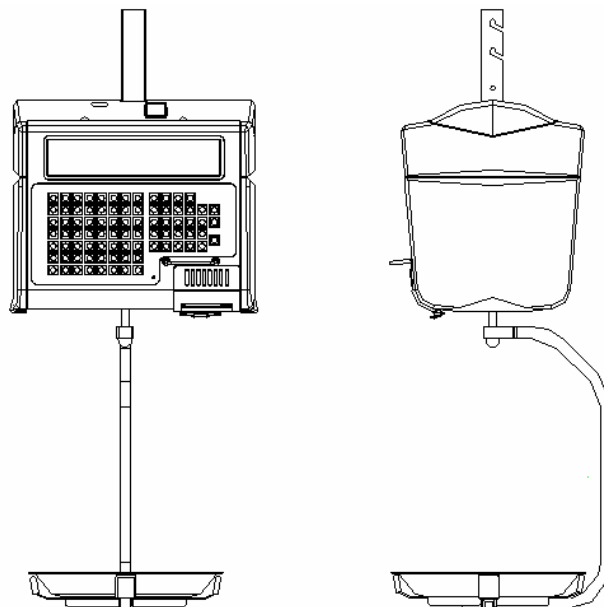

- 40Preset Keys Type

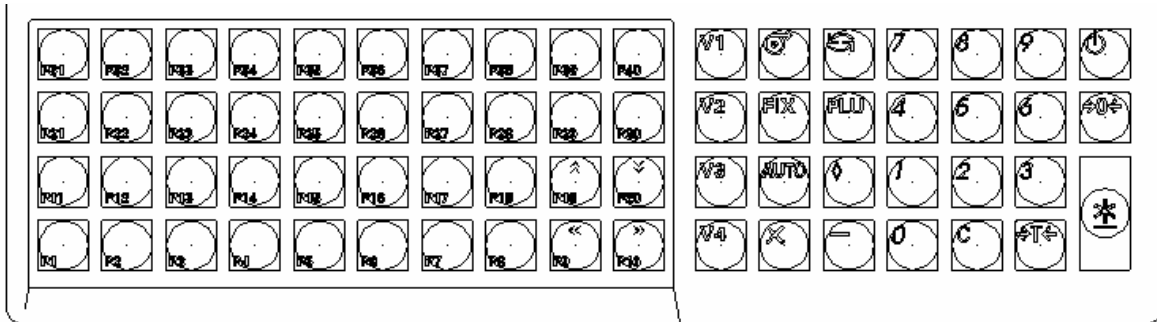

- 56 Preset Keys Type

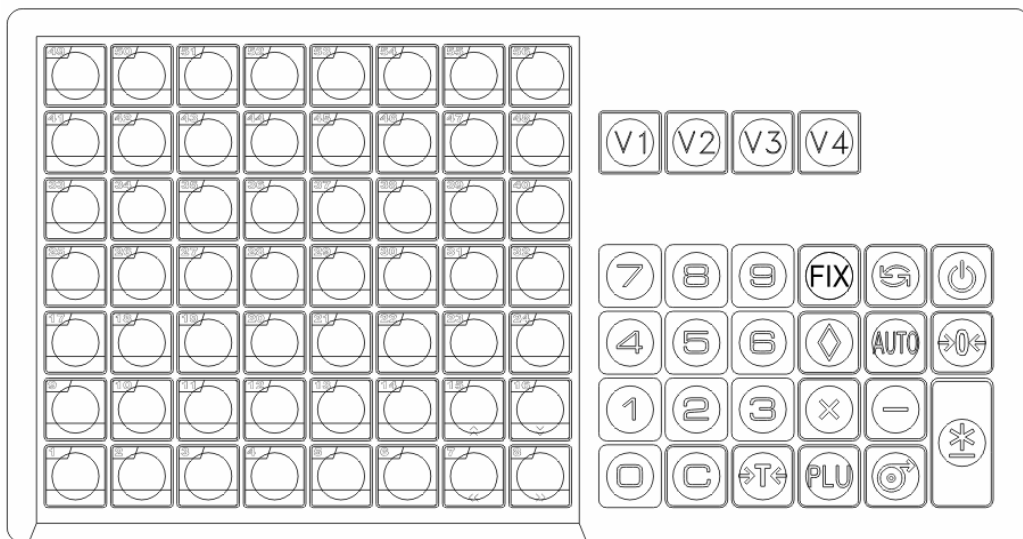

- 74 Preset Keys Type

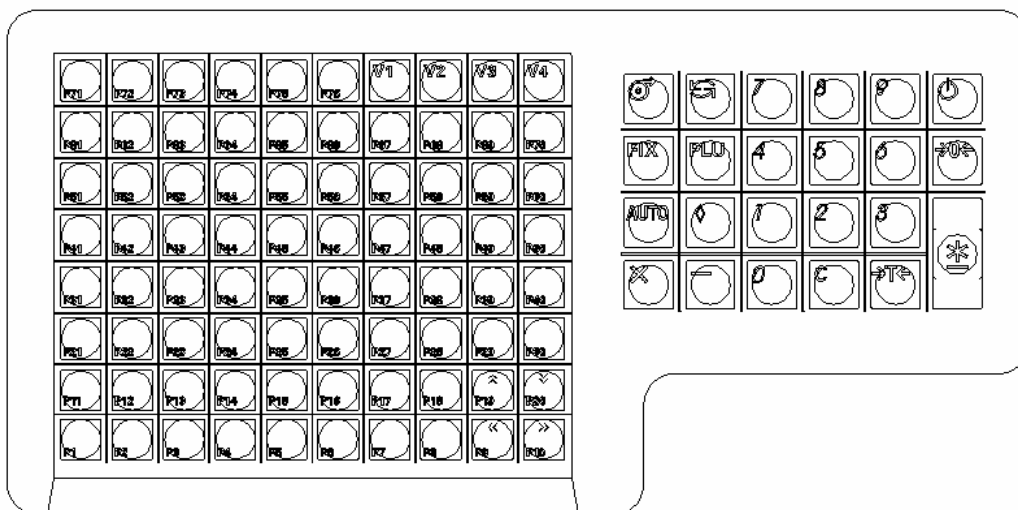

1.4 Features

- Digital printing scale consists of electronic cash registers function and label printing function.
- High-speed, high reliability thermal head printer.
- Easy paper handing achieved special designed mechanism.
- Built-in clock automatically updates data and time.
- Quick response to weight changes.
- Capacity :3kg, 6kg, 12kg, 15kg, 30kg, 6lb, 12lb, 15lb and 30lb.
- Resolution :Display Resolution 1/3, 000.
:Internal Resolution 1/90,000
- Calibrating by software.
- Customer and operator display (optional customer pole display).
- 25 digits x 19 segments TN type LCD with back-light for numeric digit and character display.

32 x 202 full dot Martix Green LCD display.

- Membrane keys
 - a. ON/OFF key
 - b. 10 Numeric keys, to key in numeric data.
 - c. 32/40/56/74 Preset keys, to preset PLU or function into the key.
 - d. 12/16 Operational keys, to perform various functional operations.
- 18 data files for Department, Main Group, PLU, etc.
- Various report.
- Ethernet function.
- Optional wireless Ethernet card.
- RS232C interface for data communicate and barcode scanner connection.
- Optional cash drawer.
- Compact housing.
-

1.5 Specifications

1.5.1 Display

25 digits × 19 segment TN type LCD with back-light for numeric digit and character display.

- Tare weight display : 4 digits.
- Weight display : 5 digits.
- Unit price display : 6 digits.
- Total price display : 7 digits.

32 x 202 full dot Martix Green LCD display.

- Tare weight display : 4 digits.
- Weight display : 5 digits.
- Unit price display : 6 digits.
- Total price display : 7 digits.

1.5.2 Operating Conditions

- Power Source : AC 176V ~ 264V, 47~63Hz.
- Operating Temperature : -10 °C ~ +40 °C.
- Operating Humidity : 15% ~ 85% RH.
- Power Consumption : 0.15A.

1.5.3 Dimensions

- Platter size

Bench ,Pole and Elevated : 386(W) x 270(D) mm.

Bench-CS and Pole-CS : 359(W) x 277(D) mm.

Hand : 274(d) x 35(h) mm.

- Overall size

- a) Bench 386(W) x 415(D) x 127(H) mm.
- b) Pole 386(W) x 478(D) x 480(H) mm.
- c) Elevated 386(W) x 416(D) x 550(H)mm.
- d) Bench-CS 380(W) x 360(D) x 162(H) mm.
- e) Pole-CS 380(W) x 380(D) x 509(H) mm.
- f) Hand 340(W) x 310(D) x 544(H) mm.

1.6 Key Functions

ON/OFF KEY



- ❖ Turn display "ON" or "OFF".

PRESET KEY

P1 ~ P74

- ❖ Set up or call either unit price and tare value.

NUMERIC KEYS

0 ~ 9

- ❖ Enter numeric data.

TARE KEY



- ❖ Set or Clear Tare value.
- ❖ Select "NO" in S and Z Mode.
- ❖ Item test print in S Mode.

CLEAR KEY

C

- ❖ For Back space or Clear numeric value.
- ❖ Select "YES" in S and Z Mode.

RE-ZERO KEY



- ❖ Reset weight to ZERO.

PREPACK KEY

AUTO

- ❖ Switch Manual mode and Pre-pack mode alternatively.
(The mode status will be indicated in the **P** and **M** indicator.)
- **P** - PRE-PACK MODE ▪ **M** - MANUAL MODE

CHANGE KEY



- ❖ Calculate the Changed Amount.
 - ❖ Escape the Programming screen without saving data in S Mode.
-

MULTIPLLE KEY

X

- ❖ Register the number of Non-Weight products.
- ❖ Select programming item such as PLU data, Shop Name in S Mode.
- ❖ Select Report Type in X Mode.
- ❖ Select Data Transaction Type in Z Mode.

CLERK KEY

V1~V4

- ❖ Accumulate the Total Price.

VOID KEY

—

- ❖ Correct the sales data.

PLU KEY

PLU

- ❖ Call up PLU data in R Mode.
- ❖ Store the programmed data in S Mode.

FEED KEY



- ❖ Feed Label or Receipt paper

PRINT KEY



- ❖ Print out Label or Receipt.
-

MODE SELECT KEY



❖ Five Modes can be selected using this key.

- **Indicator R** - REGISTRATION MODE (All the sales transactions are performed.)
 - **Indicator X** - CHECK MODE (Printing out and sales report.)
 - **Indicator S** - PROGRAM MODE (Programming preset data, such as products, data, shop name, etc.)
 - **Indicator Z** - TOTAL MODE (Clear sales data stored.)
 - **Indicator X (Blink)** - Password Setting Mode (Set PASS WORD for X, S, Z mode, set PASSWORD for PASSWORD MODE when all indicators(R, X, S, Z) blink)
-

Decrease/Increase Specification Count key



❖ Decrease/Increase Only used when Setting SPEC 141 & 142



❖ Select parameter data such as SPEC data. Move cursor left or right.

1.7 Indicators

- **ZERO** : On when zero point is adjusted and weight is stable.
- **NET** : On when tare subtraction is performed.
- **FIX T** : On when tare weight is fixed.
- **FIX P** : On when PLU or unit price is fixed.
- **P** : On when pre-pack mode is chosen; indicate capital letter is use in PLU programming.
- **M** : On when manual mode is chosen.
- **V1 ~ V4**: On when vendor transaction entries (department entry or PLU entry) are performed.
- **LABEL**: On when label printing mode is chosen.
- **R** : On when in R (normal operation) mode.
- **X** : On when in X (read report) mode.
- **S** : On when in S (programmable item setting) mode.
- **Z** : On when in Z (reset report and system maintenance) mode.

2. SETUP

2.1 Mode Change

OPERATION	DISPLAY				REMARK
	PT	kg	\$ /kg	\$	
	0.000	0.000	0.00	0.00	Weight mode.Lamp R turns on.
[MODE],[MODE] (within 3 seconds)				XMODE	Enter X mode.Lamp X turns on.
[MODE]	S1		PLU	FILE	Enter S mode.Lamp S turns on.
[MODE]	Z1.0	RESET	SALES	DAILY	Enter Z mode.Lamp Z turns on.
[MODE]		PWD X	0	SET	Enter Password Set mode.Lamp X flicker
[MODE]	0.000	0.000	0.00	0.00	Back to Weight mode.Lamp R turns on.

2.2 Specification Setting

2.2.1 Specification Entry(141)

Before setting 141, please enter Z mode.

OPERATION	DISPLAY				REMARK
	PT	kg	\$/kg	\$	
	Z1.0	RESET	SALES	DAILY	Z mode. Lamp Z turns on.
[Rezero]+[1][4][1]		SPEC 000	XXX (setting)	XXX (former)	Enter [1][4][1] while depressing [Rezero]. XXX:SPEC data
[↵]		SPEC 001	XXX	XXX	[↵]key only increase specification count, it does not update SPEC data.
[↶]		SPEC 000	XXX	XXX	[↶]key only decrease specification count, it does not update SPEC data.
[1][7] [X]		SPEC 000 SPEC 017	017 XXX	XXX XXX	It goes to a designed specification count. (000~441 is enabled)
[>>]		SPEC 017	XXX	XXX	[>>] key select SPEC data. Move cursor right.
[<<]		SPEC 017	XXX	XXX	[<<] key select SPEC data. Move cursor left.
[1] [*]		SPEC 017 SPEC 018	001 XXX	XXX XXX	
[C]		SPEC 018	000	XXX	Clear the enter data.
[PLU] * Note 1	Z1.0	RESET	SALES	DAILY	Store the updated specification and escape to Z mode.

2.2.2 Specification List

Customer SPEC Setting-(141)

SPEC NO.	SPECIFICATION DESCRIPTION	SM-100
00	Item Barcode	✓
0	F1F2 CCCCC XCD XXXX CD	All are 13 digits non-PLU barcode unless otherwise stated. #1 13 digits PLU barcode #2 8 digits PLU barcode #3 8 digits non-PLU barcode
1	F2 CCCCC XCD XXXX CD	
2	F1F2 CCCCC 0 XXXX CD	
3	F1F2 CCCCC XXXX CD	
4	F1F2 CCCCC XXXXX CD	
5	F2 CCCCC XXXXX CD	
6	F2 CCCCC XXXXXX CD	
7	F1F2 CCCCCCCCC CD #1	
8	F1F2 CCCC XXXXXX CD	
9	F1F2 CCCCC CD #2	
10	F2 CC XXXX CD #3	
11	No Barcode	
12	F1X2 CCCCC XCD XXXX CD	
13	F1X2 CCCCC XXXX CD	
14	F1F2 CCCC XCD XXXXX CD	
15	F2 CCCCC XCD XXXXX CD	
16	F1F2 CCC XXXXXXXX CD	
17	F1F2 CC XXXXXXXXX CD	
18	CCC WWWWW PPPPP CD	
19	No Barcode	
20	F1F2 CCCCC PCD XXXX CD	
01	Right Side Data of Item Barcode	✓
0	Quantity	# Related to SPEC153.
1	Price	
2	Weight	
3	User Programmable #	
4	Original Price	
5	Weight / Quantity	
6	Unit Price	
7	Unit Price after discount	
02	Right Side Price Data of Item Barcode	✓
0	Price before Tax	Effective when SPEC1 = 1
1	Price after Tax	
03	Flag Data F1 and F2 for 13 Digits Non-PLU Barcode	✓
	Enter value from range 0 to 99	
04	Flag Data F1 and F2 for 13 Digits PLU Barcode	✓
	Enter value from range 0 to 99	
05	Flag Data F2 for 8 Digit Non-PLU Barcode	✓
	Enter value from range 0 to 9	
06	Flag Data F1 and F2 for 8 Digit PLU Barcode	✓
	Enter value from range 0 to 99	
07	Total Barcode	✓
0	F1F2 CCCCC XCD XXXX CD	All are 13 digits non-PLU barcode unless otherwise stated. #1 13 digits PLU barcode #2 8 digits PLU barcode #3 8 digits non-PLU barcode
1	F2 CCCCC XCD XXXX CD	
2	F1F2 CCCCC 0 XXXX CD	
3	F1F2 CCCCC XXXX CD	
4	F1F2 CCCCC XXXXX CD	
5	F2 CCCCC XXXXX CD	
6	F2 CCCCC XXXXXX CD	
7	F1F2 CCCCCCCCC CD #1	
8	F1F2 CCCC XXXXXX CD	
9	F1F2 CCCC CD #2	
11	No Barcode	
12	F1X2 CCCCC XCD XXXX CD	
13	F1X2 CCCCC XXXX CD	
14	F1F2 CCCC XCD XXXXX CD	
15	F2 CCCCC XCD XXXXX CD	
16	F1F2 CCC XXXXXXXX CD	
17	F1F2 CC XXXXXXXXX CD	
18	CCC WWWWW PPPPP CD	
19	No Barcode	
20	F1F2 CCCC PCD XXXX CD	

08	Left Side Data of Total Label	✓
	0 Scale No. 3 Clerk No. 1 Last Accumulated Item Code 4 Fixed No. 2 Receipt No.	
09	Fixed Data for Left Side Data of Total Barcode	✓
	Enter value from range 0 to 9 999 999 999	
10	Flag Data F0, F1 and F2 for Total Barcode	✓
	Enter value from range 0 to 999	
11	Right Side Data of Total Barcode	✓
	0 Quantity 1 Price 2 Weight	
12	Total Barcode Print on Receipt	✓
	0 No 1 Yes	
13	Print Readable Character of F1 for Item and Total Barcode (for EAN only)	
	0 No Print 1 Print	
14	Printing Position for Advertisement Message	✓
	0 First Line 2 Above 1 Below 3 Not Used	
15	Turnover Printing for Advertisement Message	
	0 No 1 Yes	
16	Exit from "Change" Mode within Specified Interval	✓
	0 No 3 10 sec 1 3 sec 4 15 sec 2 6 sec	
17	Order of the Month, Day and Year for Print	✓
	0 MM/DD/YY 2 YY/MM/DD 1 DD/MM/YY 3 Not Used	
18	1 or 2 Line(s) Commodity Name on Receipt	✓
	0 2 Lines 2 No Print 1 1 Line	
19	Label Printing by Clerk Key	✓
	0 No Print 2 Print without Accumulated 1 Print with Accumulation	
20	Total Label Printing	✓
	0 No Print 1 Print	
21	Printing Operator Name on Receipt and Label	✓
	0 Code 1 Name	
22	Receipt Paper Width	✗
	0 60 mm 2 50 mm 1 40 mm	

23	Manual Price Entry for Printing or Accumulating		✓	
	0 Allow	1 Inhibit		
24	Default Label Format for Item Printing		✓	
	0 T1 (A)	12 S (T7)	Formats in () are for U1 and CA only. F1 to F8 are Free Format.	
	1 T2 (B)	13 A (T8)		
	2 T3 (C)	14 B (T9)		
	3 T4 (U2)	15 C (T10)		
	4 T5 (U3)	16 F1 (F1)		
	5 T6 (U4)	17 F2 (F2)		
	6 T7 (U5)	18 F3 (F3)		
	7 T8 (U6)	19 F4 (F4)		
	8 T9 (U7)	20 F5 (F5)		
	9 T1 (U8)	21 F6 (F6)		
	0			
	10 T1 (T5)	22 F7 (F7)		
	1			
	11 T1 (T6)	23 F8 (F8)		
	2			
25	Default Label Format for Total Printing			✓
	0 T1 (A)	12 S (T7)		Formats in () are for U1 and CA only. F1 to F8 are Free Format.
	1 T2 (B)	13 A (T8)		
	2 T3 (C)	14 B (T9)		
	3 T4 (U2)	15 C (T10)		
	4 T5 (U3)	16 F1 (F1)		
	5 T6 (U4)	17 F2 (F2)		
	6 T7 (U5)	18 F3 (F3)		
	7 T8 (U6)	19 F4 (F4)		
	8 T9 (U7)	20 F5 (F5)		
	9 T1 (U8)	21 F6 (F6)		
	0			
	10 T1 (T5)	22 F7 (F7)		
	1			
	11 T1 (T6)	23 F8 (F8)		
	2			
26	Shop Name Printing on Label		✓	
	0 No Print	1 Print		
27	Forced Tare Function		✓	
	0 Disable	1 Enable		
28	Peel Sensor Function in Prepack Mode		✓	
	0 Disable	1 Enable		
29	Continuous Print for Label in Prepack Mode		✓	
	0 Inhibit	1 Allow		
30	Selection of CDV		✗	
	0 Inhibit	1 Allow	For SF only.	
31	CDV Type		✗	
	0 CDV	1 Tear-off	For SF only.	

32	CDV Modulus			x
	0 Modulus 10	1 Modulus 11		For SF only. Effective when SPEC30 and 31 = 1.
33	On Spot Correction			✓
	0 Allow	1 Inhibit		
34	Search Correction			x
	0 Allow	1 Inhibit		
35	Move Back Correction			✓
	0 Allow	1 Inhibit		
36	Past Sales Data Correction			
	0 Allow	1 Inhibit		
37	Label Print Density			✓
	0 Low	2 High-mid		
	1 Mid	3 High		
38	Receipt Print Density			✓
	0 Low	2 High-mid		
	1 Mid	3 High		
39	Calling of PLU			✓
	0 Manual	2 Time-out		Related to SPEC40.
	1 Auto			
40	PLU Digits for Auto PLU Calling/Time-out Calling			✓
	0 3 Digits / 0.5 sec	2 5 Digits / 1.5 sec		Effective when SPEC39 = 1.
	1 4 Digits / 1.0 sec	3 6 Digits / 2.0 sec		
41	Unit Price of Weigh PLU Can Use for Price of Non-weigh PLU and Vice Versa			
	0 Allow	1 Inhibit		Effective when SPEC643 = 0.
42	Unit Price Override			✓
	0 Allow	1 Inhibit		
43	Main Usage for Commodity Name, Shop Name and Special Message			✓
	0 Receipt	1 Label		Always set to 0 for SM-200.
44	Tare Override			✓
	0 Allow	1 Inhibit		
45	Item Printing			✓
	0 Allow	1 Inhibit		
46	Default Data of Printing Shop Name Number for Label			✓
	Enter value from range 0 to 32			
47	Default Data of Printing Shop Name Number for Receipt			✓
	Enter value from range 0 to 32			

48	Setting of Scale Number		✓
	Enter value from range 0 to 999 999		
49	Type of Client / Server Interface		✓
	0 No Interface	3 Not Used	Related SPECS for Ethernet I/F are SPEC50, 135, 214.
	1 Ethernet (Coaxial Cable)	4 4-Lines (RS-485)	
	2 Ethernet (Twisted Pairs)		
50	Setting of Client / Server		✓
	0 Client	2 Backup Server	Related SPECS for S/C setting are SPEC61, 150, 163, 165, 187, 194, 208, 229, 252, 253, 254, 255, 265, 276.
	1 Server / Workstation		
51	Baud Rate of SIO (RS-232C Port)		✓
	0 1 200 bps	4 19 200 bps	Apply to both RS-232C and RS-485 ports setting for SM-300. Related SPECS are SPEC48, 52, 53, 54, 60, 134.
	1 2 400 bps	5 38 400 bps	
	2 4 800 bps	6 76 800 bps	
	3 9 600 bps		
52	Data Length of SIO (RS-232C Port)		✓
	0 7 Bits	1 8 Bits	Apply to both RS-232C and RS-485 ports setting for SM-300.
53	Parity Bit of SIO (RS-232C Port)		✓
	0 None	2 Even	Apply to both RS-232C and RS-485 ports setting for SM-300.
	1 Odd		
54	Stop Bit of SIO (RS-232C Port)		✓
	0 1 Bit	1 2 Bits	Apply to both RS-232C and RS-485 ports setting for SM-300.
55	Baud Rate of Multi-drop SIO (RS-485 / 4-Lines Port)		✗
	0 1 200 bos	3 9 600 bps	Related SPECS are SPEC48, 56, 57, 58, 59, 134.
	1 2 400 bps	4 19 200 bps	
	2 4 800 bps	5 38 400 bps	
56	Data Length of Multi-drop SIO (RS-485 / 4-Lines Port)		✗
	0 7 Bits	1 8 Bits	
57	Parity Bit of Multi-drop SIO (RS-485 / 4-Lines Port)		✗
	0 None	2 Even	
	1 Odd		
58	Stop Bit of Multi-drop SIO (RS-485 / 4-Lines Port)		✗
	0 1 Bit	1 2 Bits	
59	Multi-drop SIO (RS-485 / 4-Lines Port) Select Job		✗
	0 No Operation	2 Pick 'N' Pay #2	#1 Either SPEC59 or 60 can be selected at any one time. #2 For SF only.
	1 FIS 3000 #1		

60	SIO (RS-232C Port) Select Job			×
	0 No Operation	3 Point 'N' Shop		Apply for both RS-232C and RS-485 ports setting for SM-300. #1 Refer to SPEC59's comments #1. #2 For SM-300 only
	1 FIS 30000 #1	4 Barcode Scanning		
	2 FL-1	5 Video Control #2		
61	Floating Clerk			
	0 Inhibit	1 Allow		
62	Receipt Free Format			×
	0 Disable	1 Enable		Exclude AA.
63	SM-90 and DI-10 RS-232C Communication			×
	0 No	1 Yes		
64	Enable Password Mode			✓
	0 Allow	2 Allow Multi Password		
	1 Inhibit			
65	Report Printing in Daily and Term Transaction Clear			✓
	0 Inhibit	1 Allow		
66	Pack Quantity Function Key Enable			
	0 Allow	1 Inhibit		
67	Advertisement Function Key Enable			✓
	0 Allow	1 Inhibit		
68	Fixed Total Price Discount Function Key Enable			✓
	0 Allow	1 Inhibit		
69	Total Price Percentage Discount Function Key Enable			✓
	0 Allow	1 Inhibit		
70	Fixed Unit Price Function Key Enable			✓
	0 Allow	1 Inhibit		
71	Fixed Unit Price Percentage Function Key Enable			✓
	0 Allow	1 Inhibit		
72	Pack Date Function Key Enable			
	0 Allow	1 Inhibit		
73	Minus Pack Date Function Key Enable			
	0 Allow	1 Inhibit		
74	Sell by Date Function Key Enable			
	0 Allow	1 Inhibit		
75	Unit Symbol Function Key Enable			
	0 Allow	1 Inhibit		

76	Quantity Set Function Key Enable			
	0 Allow	1	Inhibit	
77	Price Change Function Key Enable			
	0 Allow	1	Inhibit	
78	Refund Item Function Key Enable			✓
	0 Allow	1	Inhibit	
79	Shop Name Function Key Enable			
	0 Allow	1	Inhibit	
80	Logo Function Key Enable			
	0 Allow	1	Inhibit	
81	Print Select Function Key Enable			
	0 Allow	1	Inhibit	
82	Print of Place of Production on Label			
	0 Inhibit	1	Allow	
83	Selection of Markdown			
	0 No Markdown	2	Total Price Markdown	
	1 Unit Price Markdown	3	Unit and Total Price Markdown	
84	Sub-total Function Key Enable			✓
	0 Allow	1	Inhibit	
85	Grand Total Function Key Enable			✓
	0 Allow	1	Inhibit	
86	Label Sensor Gap Value			×
	Enter value range from 0 to 255			
87	Label Type			✓
	0 Gap	1	No Gap	
88	Sell by Date Title Print out			×
	0 Inhibit	1	Allow	For AA only.
89	ASCII Code Entry in S Mode			×
	0 Inhibit	1	Allow	For AA only.
90	Sub-total Markdown			
	0 No Markdown	1	Markdown	
91	Printer Speed for Receipt			✓
	0 Slow	2	High	
	1 Normal			

92	Printer Speed for Label			✓
	0 Slow	2	High	
	1 Normal			
	Printer Stroke			✗
	0 Single	2	Not Used	
	1 Double			
93	Print Second Receipt			✓
	0 No Print	3	3 sec Delay	
	1 Continuous Print	4	User Select	
	2 1 sec Delay			
94	Position of Currency Symbol (on Label)			✓
	0 Before Price	1	After Price	
95	Receipt Printing with Dual Copy			✗
	0 Inhibit	1	Allow	
96	Advertisement Message on All Label			✓
	0 Inhibit	1	Allow	
97	Manual Print in Prepack Mode for Weigh Item			✓
	0 Inhibit	1	Allow	
98	Quantity and Unit Price Print Out for Non-weigh Item in Manual Mode			✗
	0 Allow	1	Inhibit	
99	Unit Print Out for Non-weigh Item in Manual Mode			✗
	0 Inhibit	1	Allow	
100	Discount in PLU Programming			✗
	0 Allow	1	Inhibit	
101	Zero Suppress for Date and Time			✓
	0 Disable	1	Enable	
102	Discount Presentation in Receipt			✗
	0 Discounted Unit Price and Original Price	1	Original Unit Price and Price	
103	Unit Price Assignment Function Key for PLU			
	0 Enable	1	Disable	
104	Discount Price Rounding Method			✓
	0 Rounding	2	Cut Up	
	1 Cut Down			
105	Fixed Total Price Markdown Function Key Enable			
	0 Allow	1	Inhibit	
106	Total Price Percentage Markdown Function Key Enable			
	0 Allow	1	Inhibit	
107	Fixed Unit Price Markdown Function Key Enable			
	0 Allow	1	Inhibit	

108	Fixed Unit Price Percentage Markdown Function Key Enable		
	0 Allow	1 Inhibit	
109	Source of Sell by Date		✓
	0 Real Time Clock	1 Packed Date	
110	Year Type		✕
	0 Standard	1 Japanese / Taiwan	For AA and TW only.
111	Price Symbol on Receipt		✕
	0 No Print	2 Yen	For AA only.
	1 Kanji Yen		
112	Default Data of Printing Special Message Number for Receipt		✓
	Enter value range from 0 to 16		
113	Label Logo Printing Status		✓
	0 No Print	3 Logo 3	
	1 Logo 1	4 Logo 4	
	2 Logo 2		
114	Receipt Logo Printing Status		
	0 No Print	4 Logo 3	
	1 Logo 1	5 Logo 4	
	2 Logo 2	6 Logo 1, 2, 3 and 4	
	3 Logo 1 and 2		
115	Type of Entry for Used by Date and Sell by Date		✕
	0 By Day	1 By Hour	For NICHII only.
116	Barcode Printing in First Label for Dual Label Printout		✕
	0 Print	1 No Print	For NICHII only.
117	Zero Minutes Printing		✕
	0 No Print	1 Print	For NICHII only.
118	Both Price before and after Discount		✕
	0 Price before and after Discount	1 Price before Discount only	For NICHII only.
119	Unit Symbol Printout in Receipt		✓
	0 Depend on PLU Programming	2 No Print	For AA only.
	1 Japanese PCS		
120	PLU Number Print		✓
	0 No Zero Suppress	1 Zero Suppress	
121	Thick Japanese Character Printout		✕
	0 Thick Character	1 Thin Character	For AA only.
122	Prepare Mode after Power On		✕
	0 Manual Mode	1 Prepack Mode	Always set to 0 for SM-200.
123	Printing Thank You Message on Receipt		✕
	0 Enable	1 Disable	

124	PLU Unit Price after Discount			
	0 Unit Price after Discount	1	Unit Price Discount Amount	
125	Position of Special Message on Receipt			✓
	0 Bottom	1	Top	
126	Function Keys Protection for Self-service			✕
	0 No Protection	2	Partial Protection	
	1 Full Protection			
127	Printing of Checksum for Item Barcode			
	0 Disable	1	Enable	
128	Setting of Host Number (For SM-15 Multi-drop)			✕
	Enter value between 0 to 99			For IR only.
129	Type of Host to be Communicated			✕
	0 Standalone	2	POS ECR	For IR only.
	1 TMR ECR			Use with SPEC128.
130	Selection of Print Item on Prepack Total Label			
	0 Based on Status on Item Label	1	Based on Status on Manual Total Label	
131	Print PLU Setting Quantity in Manual Mode			✓
	0 No	1	Yes	
132	Receipt Total Report			✕
	0 No	1	Yes	For DM only.
133	Change All PLU Default Format when Default SPEC Change			✕
	0 Yes	1	No	
134	Host Communication			✕
	0 No Operation	1	Enable	
	Host Communication			
	0 RS-232C	1	RS-485	
135	Port Number			✓
	Enter value from range 1 to 254			
136	One or Two Touch for Self-service Operation			✕
	0 One Touch	1	Two Touches	
137	Centering of Ingredient Data			
	0 Yes	1	No	
138	Permanent Price or Discount Price Change via Function Key			
	0 No Update to PLU	1	Update to PLU	
139	Number of Digits for Teraoka Code			✕
	0 2 Digits	1	3 Digits	
140	AA Message Size			✕
	0 24 x 24	1	16 x 16	For AA only.

141	Year Format			✓
	0 YY	1 YYYY		
142	Selection of Day Display for Sell by Date			
	0 Disable	1 Enable		
143	Peel Sensor Trigger Voltage			✕
	0 High	1 Low		
144	Display Prepack Quantity Balance			✕
	0 Enable	1 Disable		
145	Print Select Function Across the Board			
	0 Disable	1 Enable		
146	Label Format 1, 2 Function Key Enable			
	0 Inhibit	1 Allow		Exclude AA.
147	Prepack Non-add Function Key Enable			
	0 Inhibit	1 Allow		Exclude AA.
148	FIS3000 Code			✕
	0 SM-80/90 FIS3D	1 SM-25 FIS3D		
149	Main Group Function Key Enable			
	0 Inhibit	1 Allow		Exclude AA.
150	Preset Key Assignment for Client			
	0 Local Assign	1 Central Assign		
151	Change Sell by Date or Used by Date when Packed Date Changed			
	0 No	1 Yes		
152	Sell by Date or Sell by Time for Individual PLU			
	0 Disable	1 Enable		
153	User Programmable Right Side Data for Item Barcode			
	0 With Identification Digit	1 Without Identification Digit		
154	Keysheet Letter Size			✕
	0 Small Letter	1 Capital Letter		For FL & AS only.
155	Test Print on Receipt			✕
	0 No Print	1 Print		For SD only.
156	Image Copy from Free Format			
	0 Disable	1 Enable		
157	Training Mode			✕
	0 Disable	1 Enable		Exclude DEC.
158	FSD Price and Image			✕
	0 Disable	1 Enable		For U1 only.
159	½ and ¼ Key Function			✕
	0 Disable	1 Enable		

160	Twisted Pair Cable for Ethernet			×
	0 Shield	1 Unshielded		Not in used.
161	Discount Label Format			×
	0 Enable	1 Disable		For SD only.
162	Item Code Function Key Enable			
	0 Enable	1 Disable		
163	Transaction Data Store in Client Memory			
	0 Disable	1 Enable		
164	Maximum Label Length			×
	0 120 mm	1 240 mm		
165	Update Report for Client / Server System			
	0 Yes	1 No		
166	Average Price and Weight Label Function			
	0 Disable	1 Enable		
167	Label Date Title Print			×
	0 No Print	1 Print		Exclude AA.
168	GB Code			
	0 GB Code	1 Shift GB Code		For CN and MS only.
169	Print PLU Setting Unit in Manual Mode			
	0 No	1 Yes		
170	User Specification (REZERO + 141) Accessible from Z Mode Only			×
	0 No	1 Yes		
171	Euro Mode			×
	0 Disable	1 Enable		
172	Dual Declarations			×
	0 No	1 Yes		For U1 only.
173	Mask 7-segment Display in X, S and Z Mode			×
	0 No	1 Yes		For double display types only.
174	Fixed Clerk Assign to Preset Key 8, 16, 24 and 32			×
	0 Clerk Keys	1 Function Keys		For bench type only.
175	30 lb to 15 kg Conversion			×
	0 Disable	1 Enable		For UK only.
176	Discount Time on Daily Basis			✓
	0 No	1 Yes		
177	Weight Check Function			×
	0 No	1 Yes		

178	Unit Price Override per PLU		✓
	0 No	1 Yes	
179	Black Bar Sensing Label		✗
	0 Normal	1 Black Bar Sensing	
180	Scroll Message Group		
	0 Disable	1 Enable	
181	Continuos Label		
	0 Disable	1 Enable	
182	Character Size for Barcode Data		✓
	0 Large	1 Small	
183	PLU Clear after 3 Minutes Time-out		
	0 No	1 Yes	
184	Duplicate Unit and Total Price on Label		✗
	0 No Print	1 Print	Effective when SPEC158 = 1.
185	Weigh PLU Can Use for Non-weigh PLU and Vice Versa Function Key Enable		
	0 Disable	1 Enable	
186	Print \$ and Weight Unit on Label		✓
	0 No Print	1 Print	
187	Clear Total Data by Server		
	0 Both Server and Client	1 Server	
188	Tare Decimal Point Left Shift for SM-25 FIS3D		✗
	0 No	1 Yes	
189	PLU Auto Delete		
	0 No Delete	2 30 Days	
	1 15 Days	3 90 Days	
190	Swap Weight and Unit Price on Receipt		✗
	0 No	1 Yes	
191	Default Item Code Equals to PLU Number		✓
	0 No	1 Yes	
192	Nutrition Template		✗
	0 Standard	3 Standard Condensed	For U1 and CA only.
	1 Simplified	4 Tabulated	
	2 Simplified Condensed	5 Tabulated Extra Condensed	
193	Nutrition Adjustment Feed		✗
	Enter value from range 0 to 255		For U1 and CA only.
194	Server IP Address		✓
	Enter a value between 1 to 254		For Client scale only.

195	Weight Print for Non-weigh Item			
	0 No	1 Yes		
196	Scale File			
	0 Disable	1 Enable		
197	Print Format of Month			✓
	0 Number	2 3 Alphabetic		
	1 2 Alphabetic			
198	FSD Saving Calculation			✕
	0 Net Value	1 Cent Off		For U1 only.
199	FIS3000 Time Out			✕
	0 2 sec	2 32 sec		
	1 8 sec			
200	PLU Call Up Range			
	0 Disable	1 Enable		
201	Sell by Date for Manual Mode			
	0 Programmed Sell by Date	1 Zero Sell by Date		
202	Printing of Item Label when Barcode Data Overflow			✓
	0 Print	1 No Print		
203	Preset Keys Pages			✓
	0 1 Page	2 3 Pages by Shift Key		
	1 3 Pages by Toggle			
204	Reference PLU Function Key Enable			
	0 Inhibit	1 Allow		
205	Print Function Key Enable			✕
	0 Inhibit	1 Allow		
206	Print Barcode when Right Side Data Overflow			
	0 No print	1 Print Barcode Digits		
207	Weight Decimal Point Position for Barcode and Label Printing			✕
	0 Same as SPEC607	1 0.000		Effective when SPEC607 = 2.
208	Network Time Out			
	0 3 sec	2 x4		
	1 x2	3 x10		
209	FSD Calculation			✕
	0 Unit Price	1 Price Percentage Off		For U1 only.
210	PLU Repeat Function Key Enable			
	0 Inhibit	1 Allow		
211	Pick 'N' Pay Protocol			✕
	0 Old	1 New		For SF only.

212	Department Number for Pick 'N' Pay		x
	Enter a value between 1 to 99		For SF only.
213	Flag Code Function Key Enable		
	0 Inhibit	1 Allow	
214	DHCP Function		
	0 Disable	1 Enable	
215	Centering of Special Message		
	0 Yes	1 No	
216	JIS Code Table		x
	0 New	1 Old	For AA only.
217	Default Label Format 2 for Item Printing		
	0 Not Used	5 F5	
	1 F1	6 F6	
	2 F2	7 F7	
	3 F3	8 F8	
	4 F4		
218	Zero Unit Price for Unit Price Change Function Key		
	0 Inhibit	1 Allow	
219	Numeric Key Entry Reset		✓
	0 3 sec	2 Disable	For AA only.
	1 5 sec		
220	Item Barcode Right Side Data Dependent on Unit		x
	0 Disable	1 Enable	Effective when SPEC1 = 0 or 2.
221	Receipt with Tax Information Function Key Enable		x
	0 Inhibit	1 Allow	
222	Open Cash Drawer without Sales Function Key Enable		x
	0 Inhibit	1 Allow	
223	Negative Unit Price Function		
	0 Disable	1 Enable	
224	FIS3000 Wire Type		x
	0 4 wires	1 2 wires	
225	Prepack Grand Total for Individual PLU		
	0 Yes	1 No	
226	Reverse Calculation of ITF Check Digit		
	0 No	1 Yes	
227	Unit Price Override Password Function		
	0 Inhibit	1 Allow	Effective when SPEC178 = 1.

228	Individual PLU Total Transaction		
	0 No	1 Yes	
229	Preset Key Group		
	0 Disable	1 Enable	Effective when SPEC150 = 1.
230	Auto Print after PLU Call		✓
	0 No	1 Yes	
231	Zero Unit Price for PLU and Unit Price Override		✓
	0 Inhibit	1 Allow	
232	Feed for Continuous Label		✓
	0 No	1 Yes	
233	Time Format		✓
	0 24 Hours	1 12 Hours (AM/PM)	
234	Sub-total and Grand Total Barcode		
	0 Based on Item Barcode	1 Based on Total Barcode	
235	Mask Barcode Last Human Readable Check Digit		✓
	0 No	1 Yes	
236	Character Generator for Korea		×
	0 Old	1 New	For KE only.
237	Half-key Function		
	0 Inhibit	1 Allow	
238	FIS3000 Free Format Unit		×
	0 mm	2 SM-25 Dots	
	1 Dots		
239	Cheque and Credit Payment Function Key		✓
	0 Inhibit	1 Allow	
240	Voucher Payment Function Key		
	0 Inhibit	1 Allow	
241	PLU Code for IR POS and TMR		
	0 6 Digits	1 7 Digits	
242	Discount without Limit Function Key		
	0 Inhibit	1 Allow	
243	Concatenate Commodity Name Display		×
	0 No	1 Yes	
244	Enable PLU Price Change Flag		
	0 No	1 Yes	
245	Print Sell by Date or Used by Date when Date Equals Packed Date		
	0 Yes	1 No	

246	Print First and Check Digits Outside Barcode		
	0 No	1 Yes	
247	Print Packed date		
	0 Manual and Prepack Mode	2 Prepack Mode	
	1 Manual	3 No Print	
248	Print Sell by Date		
	0 Manual and Prepack Mode	2 Prepack Mode	
	1 Manual Mode	3 No Print	
249	Print Used by Date		
	0 Manual and Prepack Mode	2 Prepack Mode	
	1 Manual Mode	3 No Print	
250	Centering Shop Name on Label		✓
	0 No	1 Yes	
251	Shop Name on Receipt		✓
	0 Top	1 Bottom	
252	Auto Reconnect when Server Down		
	0 Disable	2 Every 3 min	
	1 Every 2 min	3 Every 15 min	
253	Client Auto PLU Update		
	0 Update / Delete Existing PLU	3 Update All Server PLU	
	1 Update / Delete All Sever PLU	4 Disable	
	2 Update Existing PLU		
254	Auto Update of Client Off-line Report		
	0 Disable	1 Enable	
255	Retry Ethernet Communication		
	0 2 times	1 5 times	
256	Display Price with Tax after Clerk Key Press		✕
	0 Yes	1 No	For AA only.
257	Change Place Name to PLU via Function Key		
	0 No	1 Yes	For AA only.
258	Beef Labeling		
	0 No	1 Yes	
259	Auto Print Sub-total Label in Prepack		
	0 No	1 Yes	
260	Beef Labeling : Print Country		
	0 Code	1 Name	
261	External Rewinder		
	0 Disable	1 Enable	

262	Selection of Receipt / Label		×
	0 Label	1 Receipt	Always set to 1 for SM-200.
263	FSD Net Value Minimum		×
	0 Off	1 On	For U1 only.
264	Print Ingredient Data on Next Label		
	0 Disable	1 Enable	
265	Client Using Local Free Format Label		
	0 No	1 Yes	
266	FSD Weight		×
	0 Back Computed (Single Range)	2 Exact Weight	For U1 only.
	1 Back Computed (Dual Range)		
267	CPDL Language Selection		
	0 First Language	1 Second Language	
268	Display Special Scale Message for Discounted Item		
	0 No	1 Yes	Exclude AA, HK, CN, TW and KE.
269	Auto Clerk Accumulation (for scanner)		✓
	0 No	4 V4	For IR only.
	1 V1	5 V5	
	2 V2	6 V6	
	3 V3	7 V7	
270	Individual Report Print and Clear in Z Mode		
	0 Disable	2 Auto Clear	
	1 Manual Clear		
271	Store Total Report Clear		
	0 Store Total Report Only	1 All Report	Effective when SPEC270 = 1 or 2.
272	Beef Reference Number		
	0 Code	1 Date	
273	Item Code Follow PLU Number		
	0 Yes	1 No	For IR only.
274	Bench Key Pad		×
	0 New	1 Old	
275	Taiwan Receipt Printer		×
	0 Disable	1 Enable	For TW only. Apply for POS1 FLEX PP2000 srs. 2 only.
276	Floating Server		
	0 Disable	1 Enable	

277	Real Time Buffer			
	0 No	4	5 Days	
	1 2 Days	5	6 Days	
	2 3 Days	6	7 Days	
	3 4 Days	7	Unlimited	
278	Traceability Report			
	0 Disable	3	By Date and Reference No.	
	1 By Reference No.	4	By Date and PLU No.	
	2 By PLU No.			
279	U1 Self-service			✘
	0 Disable	1	Enable	For U1 only.
280	Real Time Customer Number			
	0 No	1	Yes	
281	Real Time Buffer Receipt			✘
	0 Detail	1	Total Only	
282	Barcode Function			✘
	0 Without CR	1	With CR	
283	Barcode Look-up-table (LUT) Contents			✘
	0 Non-weigh Item Only	1	All Items	
284	Open Cash Drawer on Credit Payment			✓
	0 Allow	1	Inhibit	
285	Australia ECR Function			✘
	0 No	1	Yes	For AR only.
286	Enforce Amount Tendered			
	0 No	1	Yes	
287	Enforce Change Key			
	0 No	1	Yes	
288	Planned Price Printed in Report			
	0 Enable	1	Disable	
289	Repeat PLU Call			
	0 No	1	Yes	
290	Payment Key			✘
	0 Disable	1	Enable	For DEC countries only.
291	Gap Value In-feed Operation			✓
	0 Re-adjustable	1	No Change	
292	SM-200 Power Save			✘
	0 Back Light Off	1	Power Off	

293	SM-200 Power Save Timeout			×
	0 3 Min	2 10 Min		
	1 5 Min	3 2 Min		
	PLU Scrolling Message Display Interval			✓
	0 Disable	4 1 Min		For U1 only.
	1 3S	5 2 Min		
	2 10S	6 5 Min		
	3 30S			
294	SM-200 Battery Option			×
	0 Yes	1 No		
295	SM-300 Scrolling Message Update Rate			×
	0 6 Lines	1 12 Lines		
296	Ingredient File-Size Expansion			×
	0 Maximum 99 records	1 Maximum 255 records		For SF only.
297	Print PLU Ingredient in Receipt			×
	0 No	1 Yes		
298	Traceability Update Function			
	0 No	1 Yes		
299	Keyboard Selection			×
	0 Normal Keyboard #	2 80 Preset Keys		# 32/56 Preset Keys. Identical to SPEC672.
	1 100 Preset Keys			
300	SM-500 Self-Service			×
	0 No	1 Yes		96 Preset Keyboard. Identical to SPEC688.
301	Print Receipt after Accumulation			✓
	0 Yes	1 No		
302	Fixed Port Number for Ethernet			
	Enter value from 1 to 254			
303	DHCP IP Address Lease Time			
	0 Disable	1 Enable		
304	Server Port Number			
	Enter value from 1 to 254			
305	Character Spreading Speed Up			×
	0 Disable	1 Enable		(S3, S4, M3 & M4) For U1 only.
306	Unit Print on Receipt			
	0 Pcs	1 Items		
307	Code Page			×
	0 DOS	1 ANSI		For IR only.

308	SM-500 2 nd Receipt Printer			×
	0 Disable	1 Enable		
309	Praxis Function			×
	0 Disable	1 Enable		For DEC countries only.
310	RSS14 Barcode			
	0 Disable	1 Enable		For AI 01 only.
311	Operator Logging Function			
	0 Disable	1 Enable		
312	Price Change Password			×
	0 Disable	1 Enable		For KE only.
313	Price Change Log File			×
	0 Disable	1 Enable		For KE only.
314	Training Mode			×
	0 Disable	2 Enable (Clerk Report)		For DEC only.
	1 Enable			
315	Print PLU Traceability in Receipt			×
	0 Yes	1 No		
316	Include Prepack Total in Manual Total Report			
	0 Yes	1 No		
317	Wireless Communication			
	0 No	1 Yes		
318	Wireless FTP Port Number			
	Enter value range from 1 to 9999			Not in used.
319	Delete Traceability Record			
	0 Yes	1 No		
320	PLU Link to Text Field			
	0 Disable	1 Enable		
321	Julian Date for Packed and Sell Date			×
	0 No	1 Yes		For U1 only.
322	Price Printing Size (Large Font)			
	0 No	1 Yes		
323	Auto PLU Broadcasting			
	0 Disable	1 Enable		
324	Decimal Point For Unit Price And Total Price			×
	0 Disable	1 Enable		
325	Peel Sensor Value			
	0 Re-adjust	1 No Change		

326	ON/Off Key				×
	0 Disable		1 Enable		
327	SM300 Print Control				×
	0 Disable		1 Enable		
328	TU 9 Digit Total Price				×
	0 Disable		1 Enable		For Tu only.
329	PLU Tare Call up				×
	0 Allow		1 Inhibit		
330	Individual Scale Store Total Report				×
	0 No		1 Yes		
331	Default ITF for Barcode				✓
	0 Disable		1 Enable		
332	ITEM Text (5-16) Print on Total Label				
	0 Disable		1 Enable		
333	Image at Top Receipt				
	Enter range from 0 to 99				
334	Image at Bottom Receipt				
	Enter range from 0 to 99				
335	Traceability Eat By Date				
	0 Disable		1 Enable		
336	Traceability Max Weight				
	0 Disable		1 Enable		
337	Traceability Default Label Format				
	0 Not Used	5	F5		
	1 F1	6	F6		
	2 F2	7	F7		
	3 F3	8	F8		
	4 F4				
338	Traceability Barcode				
	0 EAN13	1	EAN128		
339	Flag Data (EAN13)				
	Enter range from 0 to 99				
340	Enforce Scan				
	0 No	1	Yes		
341	TVP2000 (SM300)				
	0 Not Send T10	1	Send T10 Label Format		
342	LCD 1 Line Scroll				
	0 Disable	1	Enable		

343	Clear Key in Prepack			
	0 Enable	1	Disable	
344	Print Pack Date			
	0 Yes	1	No	
400	Auto Power-Off Function			✓
	0 Inhibit	3	30 Minutes	
	1 3 Minutes	4	1 Hour	
	2 10 Minutes	5	3 Hours	
401	RTS/CTS Handshaking of RS-232C			✓
	0 On	1	Off	
402	Reset Receipt consecutive Number after Reset Report			✓
	0 No	1	Yes	
403	Vender Number Display in Registration Mode			✓
	0 Allow	1	Inhibit	
404	Number of Vender Keys			✓
	0 4 Vender Keys	2	6 Vender Keys	
	1 5 Vender Keys	3	7 Vender Keys	
405	Priority of Shop Name and Special Message on Receipt			✓
	0 Shop Name Priority	1	Special Message Priority	
406	Centering of shop name on Receipt			✓
	0 Allow	1	Inhibit	
407	Centering of special Message on Receipt			✓
	0 Allow	1	Inhibit	
408	One or Two Touch for Receipt Printing in AMT/TEND			✓
	0 One Touch	1	Two Touch	
409	PLU Number Printing on Receipt			✓
	0 Inhibit	1	Allow	
410	Sale Item Entry Method			✓
	0 Total	1	Item	
411	Default Vender Transaction by Print Key			✓
	0 Allow	1	Inhibit	
412	Print Checking Line			✓
	0 Print	1	No Print	
413	Source of Used by Date			✓
	0 Current Date	1	Packed Date	

414	In-Store Barcode for Barcode Scanner Enter	✓
	0 F1F2 CCCCCC TTTT CD 5 F1F2 CCCCC XCD TTTT CD 1 F1F2 CCCCC TTTTT CD 6 F1F2 CCCC XCD TTTTT CD 2 F1F2 CCCC TTTTTT CD 7 F1F2 CCCCC PCD TTTT CD 3 F1F2 CCC TTTTTTT CD 8 F1F2 CCCCC 0 TTTT CD 4 F1F2 CC TTTTTTTT CD	#1: F1F2 - 20~29 #2: CC ~ CCCCC - Item code. #3: TTTT ~ TTTTTTTT Total Price
415	Non-PLU Item Enter by Barcode Scanner	✓
	0 Allow 1 Inhibit	
416	Barcode Scanner	✓
	0 Allow 1 Inhibit	
417	Centering of Commodity Name on Label	✓
	0 Allow 1 Inhibit	
418	Weight Data Synchronization Function	✓
	0 Allow 1 Inhibit	
419	Open Cash Drawer when Issue Label	✓
	0 Allow 1 Inhibit	
420	Print Grand Total on Sales Report	✓
	0 Allow 1 Inhibit	
421	Constitution of Report	✓
	0 Receipt Data 2 Receipt Data & Label Data 1 Label Data	
422	Currency Symbol for Total Amount on Receipt	✓
	0 No Print 2 Suffixation 1 Prefixion	
423	Print Total Number of Pieces on Receipt	✓
	0 Allow 1 Inhibit	
424	Total Barcode on Receipt for Total Price in 2 nd Currency	✓
	0 Allow 1 Inhibit	For FR only.
425	Print 2 nd Currency on Receipt	✓
	0 Allow 1 Inhibit	For FR only.
426	Print Tare Weight when Unit Price is 0	✓
	0 Allow 1 Inhibit	
427	Eliminate Cash Line on Receipt when No change Operation	✓
	0 Allow 1 Inhibit	
428	PRINT Tax List on Receipt	✓
	0 Allow 1 Inhibit	Effective when SPEC603 = 1
429	Non-Weigh PLU Unit Price Display	✓
	0 Total Price Column 1 Unit Price Column	

430	Items on PLU / Main Group / Dept / Tax Report	✓
0	Registered Items	1 All Items
431	Eliminate Vender Data on Sales Report	✓
0	Allow	1 Inhibit
432	Font Size for Commodity Name on Receipt	✓
0	Standard Font Size	2 Largest Font Size
1	Larger Font Size	
433	Condition of Additional Price Rounding for Total Price	✓
0	Cash Payment Only	1 Always
434	Item Barcode Type	✓
0	EAN Type	2 User Programmable
1	ITF Type	
435	Total Barcode Type	✓
0	EAN Type	1 ITF Type
436	In-Store Barcode Type for Barcode Scanner Enter	✓
0	EAN Type	1 ITF Type
437	Print Rounding on Receipt	✓
0	Allow	1 Inhibit
438	Print Sub-Total on Receipt	✓
0	Allow	1 Inhibit
439	Pulse width for Opening Cash Drawer	✓
0	20ms (Default Value)	3 200ms
1	50ms	4 300ms
2	100ms	5 400ms
440	R Mode Password Function	✓
0	Inhibit	2 Power On & Password R Key
1	Password R Key	

2.3 Password Setting

2.3.1 Procedures of Password Setting

OPERATION	DISPLAY				REMARK
	PT	kg	\$/kg	\$	
	Z1.0	RESET	SALES	DAILY	Z mode. Lamp Z turns on.
[MODE]		PWD X	XXXX	SET	Display password for X mode . XXXX: former password 0: Not set (1~4 bits are enable)Lamp X flicker.
[1][2][3][4] [*]		PWD X PWD S	1234 XXXX	SET SET	Set password for X mode as 1234. Press [*] to save password for X mode. Lamp S flicker.
[*]		PWD Z	XXXX	SET	Display password for Z mode. Lamp Z flicker.
[3][3] [C]		PWD Z PWD Z	33 0	SET SET	Clear the password for Z mode.
[*]		PWD P	XXXX	SET	Display password for PWD mode. Lamp R X S Z flicker.
[1][1][1][1]		PWD P	1111	SET	Set password for PWD mode as 1111. Lamp R X S Z flicker.
[*]	0.000	0.000	0.00	0.00	Return R mode after password setting.

2.3.2 Password Using

{Hypothesis: PWD X: 1111; PWD S: No Set; PWD P: 1234}

OPERATION	DISPLAY				REMARK
	PT	kg	\$ /kg	\$	
	0.000	0.000	0.00	0.00	Weight mode. Lamp R turns on.
[MODE],[MODE] (within 3 seconds)		ENTER	PWD X		Need X mode password. Lamp X turns on.
[1][2][3][4] [*]		ENTER ENTER	PWD X PWD X	****	Incorrect password. Retry.
[1][1][1][1] [*]	X1.0	ENTER READ	PWD X SALES	**** DAILY	Correct password. Enters X mode.
[MODE]	S1		PLU	FILE	Enters S mode. Lamp S turns on.
[MODE]		ENTER	PWD Z		Need Z mode password. Lamp Z turns on.
[3][3] [*]	Z1.0	ENTER RESET	PWD Z SALES	** DAILY	Correct password. Enters Z mode.
[MODE]		ENTER	PWD P		Need PWD mode password.
[1][2][3][4] [*]		ENTER PWD X	PWD P 1111	**** SET	Correct password. Enters PWD mode.
[MODE]	0.000	0.000	0.00	0.00	Back to Weight mode. Lamp R turns on.

2.4 Clear Files

This function is used to clear files in Memory.

OPERATION	DISPLAY				REMARK
	PT	kg	\$ /kg	\$	
	Z1.0	RESET	SALES	DAILY	Z mode. Lamp Z turns on.
[Rezero]+[2][3][0]		CLEAR	PLU	FILE	PLU file.
[M]		CLEAR	VENDER	DATA	Vender transaction data.
[M]		CLEAR	REPORT	FILES	Report files.
[M]		CLEAR	MEMORY	DATA	All files in memory.
[*]		CLEAR	MEMORY	Y-C N-T	[C] to clear file data,[T] to quit.
[C] or [T]	Z1.0	RESET	SALES	DAILY	Return to Z mode.

3. PROGRAM MODE

3.1 Programmable Files

In Programming Mode, there are two ways to select the Programming File by using different keys such as:

- Enter the Number key.
- Press [^] key or [v] key to select the Data File.

The files listed below can be programmed in PROGRAM Mode (**S Mode**).

Key To Press	Data files	Key To Press	Data files
[1]	PLU Programming	[1] [7]	Logo Programming
[2]	Department Programming	[1] [8]	Tax Programming
[3]	Main Group Programming	[1] [9]	Program or Skip Item Data
[4]	Key Assignment	[2] [0]	Memory Status
[5]	Shop Name Programming	[2] [1]	I/F Test
[6]	Advertisement Programming	[2] [2]	File Load
[7]	Vender Programming		
[8]	Date and Time Programming		
[9]	Special Message Programming		
[1] [0]	Ingredients Programming		
[1] [1]	Text Programming		
[1] [2]	Free Format Programming		
[1] [3]	Scrolling Message Programming		
[1] [4]	Scroll Sequence Programming		
[1] [5]	Place Programming		
[1] [6]	Machine setting		

3.2 General Explanation

DEPARTMENT, MAIN GROUP and **PLU** files are connected as shown below. By the following linking method, more detail and concrete information on sales transaction or pre-pack data can be got by printing various reports.

◆ DEPARTMENT FILE

DEPARTMENT file is the largest category whose items are like MEAT, FISH, VEGETABLE or DELICATESSEN etc.

◆ MAIN GROUP FILE

MAIN GROUP file is the middle category including items such as BEEF, PORK, CHICKEN, etc. You can link a Main Group to a Department in the Main Group file. Tax Number can be assigned to a Main Group. The assigned Tax Number will apply for all the PLU's assigned to the Main Group.

◆ PLU FILE

PLU File is the smallest category including items such as BEEF SLICE, BEEF SHOULDER and BEEF SIRLOIN. You can link the PLU to a Main Group in the PLU programming file.

Connection of DEPARTMENT, MAIN GROUP and PLU:

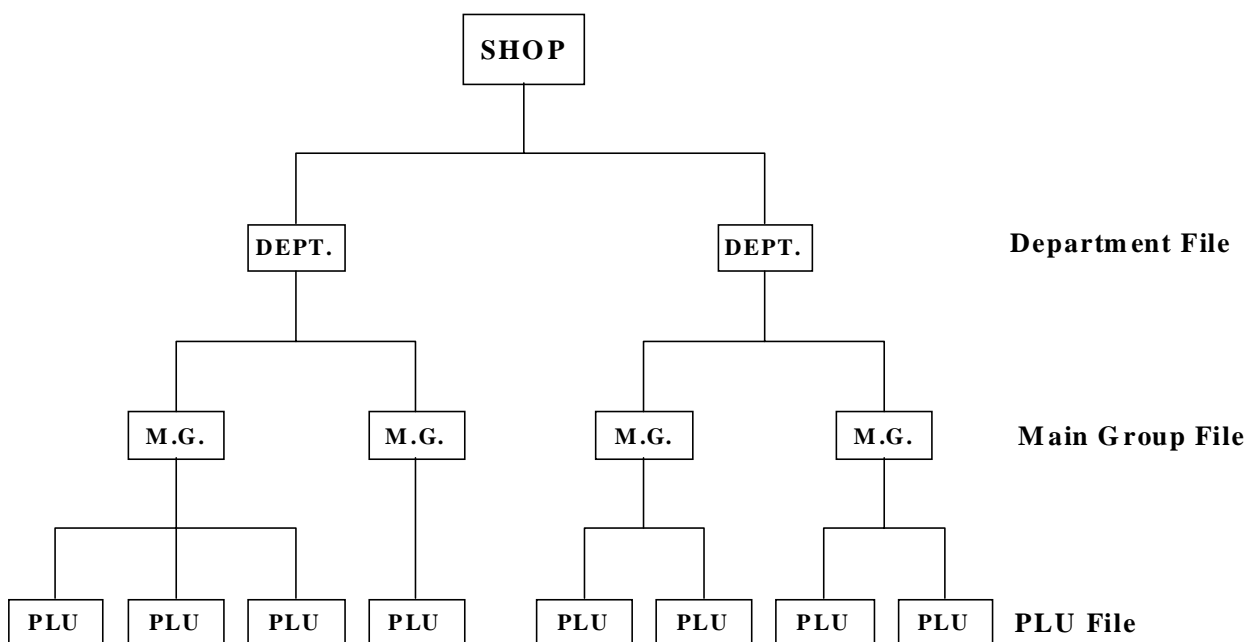

3.3 Department Files

Department file is used for categorizing Main Groups. Department Number between 1 ~ 99 are available for programming. The Main Groups that are not linked to any Department will be assigned to Department Number 97 automatically. Maximum 16 characters per file are available and each with 1 line.

3.3.1 Program Department File

OPERATION	DISPLAY				REMARK
	PT	kg	\$ /kg	\$	
[MODE][MODE] [MODE]	S1		PLU	FILE	Enter S mode. Lamp S turns on.
[2] or [X], [≡]	S2		DEPT	FILE	Select Department Programming.
[*]	S2.0	DEPT	0	NO SET	\$ /kg window displays DEPT. code.
[1]	S2.0	DEPT	1	NO SET	Enter department No.(Ex. [1])
[*]	S2.1	DEPT		NAME 0	Enter department programming, set the department name.
[M][E][A][T]	S2.1	DEPT	MEAT	NAME 4	Enter DEPT. name(use letter keys)(Ex. "MEAT" for Dept. No 1) The methods of ASCII letter input refer to <i>3.23 ASCII Character Input Method.</i>
[PLU]	S2		DEPT	FILE	Store the department file, back to S mode.

Note1: Number after "NAME" in Total display shows the position of the cursor.

Note2: The DEPT. No.1 to No.99 are available for programming.

(No.97 is default No. for PLU programming, and the PLUs which are not linked to any DEPT No. are assigned to No.97)

(Non-PLU files (Weighing items) are assigned to DEPT code No.98)

(Non-PLU files (Non-weighing items) are assigned to DEPT code No.99)

Note3: The Department names programmed are not printed on the label/receipt but are for reporting.

3.3.2 Delete Department File

OPERATION	DISPLAY				REMARK
	PT	kg	\$ /kg	\$	
[MODE][MODE] [MODE]	S1		PLU	FILE	Enter S mode. Lamp S turns on.
[2] or [≡]	S2		DEPT	FILE	Select Department Programming.
[*]	S2.0	DEPT	0	NO SET	\$ /kg window indicates DEPT. code.
[1]	S2.0	DEPT	1	NO SET	Enter department No.(Ex. [1]) Delete Dept. No.1 for “MEAT”.
[-]	S2.0	DEPT	DEL ?	Y-C N-T	[C] for Yes, [T] for No.
[C]	S2		DEPT	FILE	Delete the Dept. file 1, back to S mode.

Note: When the MAIN GROUP FILE exists under the Department File, the Department Number cannot be deleted. In addition, the Department Number 97, 98 and 99 cannot be deleted.

3.4 Main Group Files

Main Group is the middle category and can be assigned to a Department. The Main Group file is used for categorizing the PLU's. Main Group Number of 1 ~ 999 are available for programming. PLU's that are not linked to any Main Group Number will be assigned to the Main Group Number 997 automatically. TAX is assigned to every Main Group. The assigned TAX will apply for all the PLU's assigned to the Main Group. Up to 250 data can be programmed in Main Group file. Maximum 16 characters per file are available and each with 1 line.

3.4.1 Program Main Group File

OPERATION	DISPLAY				REMARK
	PT	kg	\$ /kg	\$	
[MODE][MODE] [MODE]	S1		PLU	FILE	Enter S mode. Lamp S turns on.
[3] or [≡]	S3		MGROUP	FILE	Select Main Group Programming.
[*]	S3.0	MG	0	NO SET	\$ /kg window indicates Main Group code.
[1][1][1]	S3.0	MG	111	NO SET	Select Main Group No. (Ex. [1][1][1])
[*]	S3.1	MG	97 (default)	DEPT NO	Enter Main Group programming, Set the Department number.
[1]	S3.1	MG	1	DEPT NO	Link Main Group 111 to Department 1.
[*]	S3.2	MG		NAME 0	
[B][E][E][F]	S3.2	MG	BEEF	NAME 4	Name of the Main Group 111 is "BEEF". Set the Tax number.
[*]	S3.3	MG	0	TAX NO	
[1]	S3.3	MG	1	TAX NO	Tax of Main Group 111 is tax number 1.
[PLU]	S3		MGROUP	FILE	Store the Main Group file, back to S mode. If you want to exit without saving data, press [] key and then follow by [C] key

Note1: For tax rate programming, refer to 3.20 Tax File in S Mode. if not necessary to link the Tax Number, press [*] key to enter next selection. This procedure will skip if **SPEC 603** is set to "NO TAX".

Note2: Number after "NAME" in Total display shows the position of the cursor.

Note3: The Main Group No.1 to No.997 are available for PLU programming.

(No.997 is default No. for PLU programming, and the PLUs which are not linked to any Main Group No. are assigned to No.997)

(Non-PLU files (Weighing items) are assigned to Main Group code No.998)

(Non-PLU files (Non-weighing items) are assigned to Main Group code No.999)

Note4: The Main Group names programmed are not printed on the label/receipt but are for reporting.

Note5: Each Main Group No. must be linked to the exiting Dept. No.(Refer to 3.3 *Department File*).

3.4.2 Delete Main Group File

OPERATION	DISPLAY				REMARK
	PT	kg	\$ /kg	\$	
[MODE][MODE] [MODE]	S1		PLU	FILE	Enter S mode. Lamp S turns on.
[3] or [≡] [*]	S3 S3.0	MG	MGROUP 0	FILE NO SET	Select Main Group Programming and Enter it.
[1][1][1]	S3.0	MG	111	NO SET	Enter Main Group No. (Ex. [1][1][1])
[-]	S3.0	MG	DEL ?	Y-C N-T	[C] for Yes, [T] for No.
[C]	S3		MGROUP	FILE	Delete M.G. file 111,back to S mode.

Note1: When the PLU FILE exists under the Main Group File, the Main Group Number cannot be deleted. In addition, the Main Group Number 997, 998 and 999 cannot be deleted.

3.5 Program / Skip Item Data

Unnecessary PLU parameters will be skipped automatically due to auto-skip function, it is possible to set only necessary PLU parameter in PLU programming procedure "Program PLU File". The following parameters are available for Program/ Skip function

No.	Display	Parameter	Symbol
1	[LABFR1]	1. Label format 1	LABFR1
2	[LABFR2]	2. Label format 2	LABFR2
3	[BACODE]	3. Barcode Selection	BACODE
4	[FLAG]	4. Barcode Flag data	FLAG
5	[ITCODE]	5. Barcode Item Code	ITCODE
6	[MGCODE]	6. Main Group Code	MGCODE
7	[SELLDT]	7. Sell by Date	SELLDT
8	[SELLTM]	8. Sell by Time	SELLTM
9	[USEDDET]	9. Used by Date	USEDDET
10	[PACKDT]	10. Packed Date	PACKDT
11	[PACKTM]	11. Packed Time	PACKTM
12	[COST]	12. Cost	COST
13	[TARE]	13. Tare	TARE
14	[QTY]	14. Quantity	QTY
15	[Q.UNIT]	15. Quantity Unit	QUNIT
16	[DISCNT]	16. Discount Status	DISCNT
17	[SCH DT]	17. Discount Schedule date	SCHDT
18	[SCH TM]	18. Discount Schedule time	SCHTM
19	[MARKDN]	19. Mark Down Status	MARKDN
20	[1STLMT]	20. 1st target for discount 1	FSTLMT
21	[2NDLMT]	21. 2nd target for discount 2	SNDLMT
22	[SMGNUM]	22. Special Message #	SMGNUM
23	[INGNUM]	23. Ingredients #	INGNUM
24	[COMNAM]	24. Commodity Name	COMNAM
25	[SP MG]	25. Special Message	SPMG
26	[INGR]	26. Ingredients	INGR
27	[PLCNUM]	27. Place of Production	PLCNUM
28	[IMAGE]	28. Image	IMAGE
29	[BONUS]	29. Bonus	BONUS
30	[NUTRI]	30. Nutrition	NUTRI
31	[ITFSEL]	31. ITF Selection	ITFSEL
32	[REFPLU]	32. Reference PLU No.	REFPLU
33	[SECPLU]	33. Security PLU	SECPLU
34	[COUPLU]	34. Coupled PLU	COUPLU

No.	Display	Parameter	Symbol
35	[DAY WK]	35. Discount day of the week	DAYWK
36	[ADD-ON]	36. EAN 5 Digit ADD-ON	ADDON
37	[TAX]	37. TAX No.	TAX
38	[PRICE2]	38. 2nd Price	PRICE2
39	[% TARE]	39. Proportional Tare	PROTARE
40	[CUSDIS]	40. Customer Discount	CUSDIS
41	[RESDIS]	41. Restaurant Discount	RESDIS
42	[STADIS]	42. Staff Discount	STADIS
43	[TRACE]	43. Traceability Discount	TRACE
44	[TEMP]	44. Storage Temperature	TEMP
45	[PACK.I]	45. Pack. Indicator	PACKI
46	[M1BARC]	46. Multi Barcode 1	M1BARC
47	[M2BARC]	47. Multi Barcode 2	M2BARC
48	[TM1BAR]	48. Total Multi Barcode 1	TM1BAR
49	[TM2BAR]	49. Total Multi Barcode 2	TM2BAR
50	[U.PRIC]	50. Unit Price Selection	UPRIC
51	[PLUSCR]	51. PLU Scroll (U1 only)	PLUSCR
52	[PLUTEX]	52. PLU Linked Text Field	PLUTEX

Program/Skip Item Data

OPERATION	DISPLAY				REMARK
	PT	kg	\$ /kg	\$	
[MODE][MODE] [MODE]	S1		PLU	FILE	Enter S mode. Lamp S turns on.
[1][9] or [≡]	S19		PLU	ITEM	Select PLU item Selection Mode and enter
[*]	S19.1	ITEM	LABFR1	PROGRAM	Enter Program or Skip parameter selection mode.
[*][*][*][*][*]	S19.1	ITEM	MGCODE	SKIP	Select parameter of Main Group.
[X]	S19.1	ITEM	MGCODE	PROGRAM	Select PROGRAM for the parameter of Main Group.
[PLU]	S19		PLU	ITEM	After finish setting, save it. Back to S mode.

Note1: Press [*] key to next parameter or [-] key to previous parameter and press [X] key to select PROGRAM or SKIP for each parameter, if necessary.

Note2: If you want to exit without saving, press [] key follow by [C] key.

3.6 PLU Programming

The following items can be programmed in PLU PROGRAMMING mode. The format chosen for the PLU will decide what items can be programmed in the PLU file. The items which print areas are not set on the selected format will skip automatically or not printed on label. (If the item doesn't appear on the PLU programming, check whether the parameter is set to ENABLE in Program / Skip Item Data).

PLU file for weighing item and non-weighing item listed below can be programmed according to the following order.

Weighing Item

Step	PLU File (weighing Item)	Remarks
P1.0	PLU No.	
P1.1	Unit Price (6 digits)	
P1.2	Label Format for the 1st label	<i>Refer to Label Format List.</i>
P1.3	Label Format for the 2nd label	<i>Free format No. 1~99 only.</i>
P1.4	Commodity Name Font Size	
P1.4	Commodity Name	
P1.5	Selection of ITF Barcode Format	
P1.6	Bar Code Selection	
P1.7	Flag data	<i>* Digits of Flag and Item data can be selected in the barcode type selection in P1.6.</i>
P1.8	Item Code No.	
P1.9	Item Code No. (Lower 4 digits)	<i>Only when Item Code is more than 6 digits.</i>
P1.10	Right Side Data of Item Barcode	<i>Only when Spec02 set to 3.</i>
P1.11	Selection of EAN ADD-ON	
P1.12	Main Group No.	
P1.13	Select whether to print Sell by date	<i>* If No Print is selected, Sell- by Date in P1.12 is skipped.</i>
P1.14	Sell by date (Days after the current date)	
P1.15	Select whether to print Sell by time	<i>* If No Print is selected, Key in selection in P1.14 Sell-by time in P1.15 is skipped.</i>
P1.16	Select key-in data or present time	
P1.17	Sell by Time (If Key-In is selected)	<i>* If P1.14 select CLOCK TIME, Key in selection in P1.15 is skipped.</i>
P1.18	Select whether to print Used by date	<i>* If No Print is selected, Used- by Date in P1.17 is skipped.</i>
P1.19	Used by date (days after Packed date)	
P1.20	Select whether to print Packed date	<i>* If No Print is selected, Packed Date in P1.19 is skipped.</i>
P1.21	Packed Date (days after actual packed date)	
P1.22	Select whether to print Packed time	<i>* If No Print is selected, Key-in selection in P1.21 Packed time in P1.22 are skipped.</i>

Step	PLU File (weighing Item)	Remarks
P1.23	Select to print Key-In data or actual time	* If P1.21 select CLOCK TIME, Key in selection in P1.22 is skipped.
P1.24	Packed Time (if key-In is selected)	
P1.25	Cost price	
P1.26	PLU Tare	* Depends on SPEC: 647 SETTING.
P1.29	Type of Volume Discount	* Depends on SPEC: 100 SETTING.
P1.30	The 1st target of volume discount	* If No Volume discount is selected, the parameters in P1.27 ~ P1.36 are skipped.
P1.31	The discount value for the 1st target	
P1.32	The 2nd target of volume discount	
P1.33	The discount value for the 2nd target	
P1.34	Print type of Discount price (Mark Down)	*Entering by Number keys (0~3)
P1.35	Schedule of Volume Discount (The start date)	
P1.36	Schedule of Volume Discount (The start time)	
P1.37	Schedule of Volume Discount (The end date)	
P1.38	Schedule of Volume Discount (The end time)	
P1.39	Selection of Discount Day of The Week.	
P1.40	Special message No. (Select No. from S/message file)	* If selected Label Format without PRINT AREA, P1.37 ~ P1.40 are skipped.
P1.41	Ingredient No. (Select No. from Ingredient file)	
P1.42	Special message (Program original Special Message)	
P1.43	Ingredient (Program original Ingredient)	
P1.44	Place of production (Select No. from Place file)	* If selected Label Format without PRINT AREA, the PLACE message will print on 1 st line of Commodity Name.
P1.45	Coupled PLU Number	
P1.46	TAX Number (Select Number from TAX File)	*Depend on SPEC: 603 SETTING.
P1.47	Reference PLU Number	
P1.48	Proportional Tare	*Depend on SPEC: 687 SETTING.

Non-Weighing Item

Step	PLU File (Non-weighing Item)	Remarks
P1.0	PLU No.	
P1.1	Unit Price (6 digits)	
P1.2	Label Format for the 1st label	<i>Refer to Label Format List.</i>
P1.3	Label Format for the 2nd label	<i>Free format No.1~99 only.</i>
P1.4	Commodity Name Font Size	
P1.4	Commodity Name	
P1.5	Selection of ITF Barcode Format	
P1.6	Bar Code Selection	
P1.7	Flag data	<i>* Digits of Flag and Item data can be selected in the barcode type selection in P1.6.</i>
P1.8	Item Code No.	
P1.9	Item Code No. (Lower 4 digits)	<i>Only when Item Code is more than 6 digits.</i>
P1.10	Right Side Data of Item Barcode	<i>Only when Spec02 set to 3.</i>
P1.11	Selection of EAN ADD-ON	
P1.12	Main Group No.	
P1.13	Select whether to print Sell by date	<i>* If No Print is selected, Sell- by Date in P1.12 is skipped.</i>
P1.14	Sell by date (Days after the current date)	
P1.15	Select whether to print Sell by time	<i>* If No Print is selected, Key in selection in P1.14 Sell-by time in P1.15 is skipped.</i>
P1.16	Select key-in data or present time	<i>* If P1.14 select CLOCK TIME, Key in selection in P1.15 is skipped.</i>
P1.17	Sell by Time (If Key-In is selected)	
P1.18	Select whether to print Used by date	<i>* If No Print is selected, Used- by Date in P1.17 is skipped.</i>
P1.19	Used by date (days after Packed date)	
P1.20	Select whether to print Packed date	<i>* If No Print is selected, Packed Date in P1.19 is skipped.</i>
P1.21	Packed Date (days after actual packed date)	
P1.22	Select whether to print Packed time	<i>* If No Print is selected, Key-in selection in P1.21 Packed time in P1.22 are skipped.</i>
P1.23	Select to print Key-In data or actual time	<i>* If P1.21 select CLOCK TIME, Key in selection in P1.22 is skipped.</i>
P1.24	Packed Time (if key-In is selected)	
P1.25	Cost price	
P1.27	Unit Symbol (PCS / FOR / kg / lb / g / NO SYMBOL)	
P1.28	Quantity	
P1.29	Type of Volume Discount	<i>* Depends on SPEC: 100 SETTING.</i>

Step	PLU File (Non-weighing Item)	Remarks
P1.30	The 1 st target of volume discount	<i>* If No Volume discount is selected, the parameters in P1.27 ~ P1.36 are skipped.</i>
P1.31	The discount value for the 1st target	
P1.32	The 2nd target of volume discount	
P1.33	The discount value for the 2nd target	
P1.34	Print type of Discount price (Mark Down)	<i>*Entering by Number keys (0~3)</i>
P1.35	Schedule of Volume Discount (The start date)	
P1.36	Schedule of Volume Discount (The start time)	
P1.37	Schedule of Volume Discount (The end date)	
P1.38	Schedule of Volume Discount (The end time)	
P1.39	Selection of Discount Day of The Week.	
P1.40	Special message No. (Select No. from S/message file)	<i>* If selected Label Format without PRINT AREA, P1.37 ~ P1.40 are skipped.</i>
P1.41	Ingredient No. (Select No. from Ingredient file)	
P1.42	Special message (Program original Special Message)	
P1.43	Ingredient (Program original Ingredient)	
P1.44	Place of production (Select No. from Place file)	<i>* If selected Label Format without PRINT AREA, the PLACE message will print on 1st line of Commodity Name.</i>
P1.45	Coupled PLU Number	
P1.46	TAX Number (Select Number from TAX File)	<i>*Depend on SPEC: 603 SETTING.</i>
P1.47	Reference PLU Number	

3.6.1 Program PLU File(weighing item)

PLU data(weighing item) is programmed by following procedure as below.

If the selected 1st or 2nd label format does not have print area for the PLU items, the item will be skipped automatically or not printed on label.

OPERATION	DISPLAY				REMARK
	PT	kg	\$ /kg	\$	
[MODE][MODE] [MODE]	S1		PLU	FILE	Enter S mode. Lamp S turns on.
[*]	S1.0	PLU	0	NO SET	Enter PLU programming mode. \$ /kg window displays PLU number.
[1][0][0]	S1.0	PLU	100	NO SET	Enter new PLU Number (Ex. 100) you want.
[*]	S1.1	PLU	0.00	PR-KG	Enter PLU programming. Enter unit price.(Ex.5.80 \$ /kg)
[5][8][0][*]	S1.2	PLU	DFT	0 LAB FR1	Select Label format for 1 st Label by press [<<] or [>>] key. (T1~T12,S,A,B,C,F1~F8 is available)
[<<] or [>>]	S1.2	PLU	T6	6 LAB FR1	Set the Label format (Ex.T6) by press [6] or [>>] key.
[*]	S1.3	PLU	NO	0 LAB FR2	Select Label format for 2 nd Label by press [<<] or [>>]key. (F1~F8 only)
[<<] or [>>] [*]	S1.4	C01.01		S1 A 100	Enter commodity name.(Ex. "SLICE")
[S][L][I][C][E] [*]	S1.4	C02.01		S1 A 100	Enter the 2 nd line of commodity name.
[*]	S1.5	PLU	EAN	BARCODE	Select the type of BARCODE by press [X] or [>>].(EAN or ITF)
[*]	S1.6	PLU	DFLT	BARCODE	Select barcode format by press [<<] or [>>] key.(Ex.2f5c4i4wD)
[<<] or [>>] [*]	S1.7	PLU	20	FLAG	Set flag data.(Ex.29) The Default Flag Data can be set at SPEC 3 ~ 6 and the Flag data consists of one or two digits, which depends on the selected Barcode type.
[2][9] [*]	S1.8	PLU	00000	IT CODE	Enter item code.(Ex.10010)

OPERATION	DISPLAY				REMARK
	PT	kg	\$ /kg	\$	
[1][0][0][1][0] [*]	S1.9	PLU	00000	EX CODE	No appended item code of PLU 100.
[*]	S1.10	PLU	EAN	ADD OFF	Select EAN ADD-ON or EAN ADD-OFF.(Ex. EAN ADD-OFF)
[*]	S1.12	PLU	997	MG NO	Set the Main Group number.(default MG 997) Enter Main Group No.(Ex.111) Link PLU 100 to Main Group 111.
[1][1][1] [*]	S1.13	PLU	NPRINT	SELL DT	Press [<<] or [>>] key to change whether print sell-by-date. (Ex. Print sell by date)
[<<] or [>>] [*]	S1.14	PLU	0	SELL DT	Set sell-by-date.(Ex.3 days) 3 digits can be set.(0~999)
[3] [*]	S1.15	PLU	NPRINT	SELL TM	Press [<<] or [>>] key to change whether print sell-by-time. (Ex. No print sell by time)
[*]	S1.18	PLU	NPRINT	USED DT	Press [<<] or [>>] key to change whether print used by date. (Ex. No print used by date)
Set used-by-date, used-by-time	Setting way of used-by-date, used-by-time are same as setting sell-by-date and sell-by-time.
[*]	S1.20	PLU	NPRINT	PACK DT	Press [<<] or [>>] key to change whether print packed date.
[<<] or [>>] [*]	S1.21	PLU	0	PACK DT	If necessarily, packed date can set the day after present date. (Ex. 1 day after present day)
[1][*]	S1.22	PLU	NPRINT	PACK TM	Press [<<] or [>>] key to change whether print packed time.
[<<] or [>>] [*]	S1.23	PLU	TIME	PRESENT	Press [<<] or [>>] key to change key-in time or present time.
[<<] or [>>] [*]	S1.24	PLU	0000	PACK TM	Set the packed time. (Ex. 18:00)
[1][8][0][0] [*]	S1.25	PLU	0.00	COST	
[*]	S1.26	PLU	0.000	TARE	Enter Preset Tare of PLU 10.(Ex.0.100kg)

OPERATION	DISPLAY				REMARK
	PT	kg	\$ /kg	\$	
[1][0][0] [*]	S1.29	PLU	NO	DISCONT	6 kinds discount type can be selected by press [<lt;<] [>>]="" key.<br="" or=""></lt;<]> (Ex. UNIT PRICE discount)
[<<] or [>>] [*]	S1.30	PLU	0.000	1 ST LMT	Set 1 st limit weight is 0.1kg.(Ex.0.100kg)
[1][0][0] [*]	S1.31	PLU	0.00	1 ST AMT	Set 1 st amount of discount is \$ 0.30.
[3][0] [*]	S1.32	PLU	99.999	2 ND LMT	Set 2 nd limit weight is 1.000kg.
[1][0][0][0] [*]	S1.33	PLU	0.00	2 ND AMT	Set 2 nd amount of discount is \$ 0.50.
[5][0] [*]	S1.34	PLU	NO	MARK DOWN	Change selection by [<<] or [>>]: No mark down/Unit price mark down /Total price mark down/all mark down
[<<] or [>>] [*]	S1.35	PLU	000000	ST DATE	Set discount start day.(Ex.10-01-04, MM-DD-YY)
[1][0][0][1][0][4] [*]	S1.36	PLU	0000	ST TIME	Set discount start time.(Ex. 09:00, HH-MM)
[0][9][0][0] [*]	S1.37	PLU	000000	ED DATE	Set discount end date.(Ex.11-01-04)
[1][1][0][1][0][4] [*]	S1.38	PLU	0000	ED TIME	Set discount end time.(Ex. 09:00)
[0][9][0][0] [*]	S1.40	PLU	0	SMG NUM	Set special message file number.(Ex. Number 1) Special message file 1 is linked to this PLU.
[1][*] [*]	S1.41	PLU	0	ING NUM	Set ingredients file number.(Ex. Number 1) Ingredients file 1 is linked to this PLU.
[1] [PLU]	S1		PLU	ITEM	After finish setting, save it. Back to S mode.

Note1: Press [*] key to next parameter or [-] key to previous parameter.

Note2: The letter before "A" in Total Price display shows the letter font size of the commodity name, and the number after "A" in Total Price display shows the number of letters can be programmed for commodity name.

Note3: The 2 digits after "C" in Weight display shows the line of the commodity name, and the next 2 digits in Weight display shows the position of the cursor.

Note4: The PLU No.1 to No.999999 are available for PLU programming.

Note5: The programmed PLU commodity name are printed on the label or receipt.

Note6: Max.100 letters for commodity name per file are available.

Note7: Each PLU No. must be linked to the exiting Main Group No.(Refer to 3.4 Main Group File).

3.6.2 Program PLU File(non-weighing item)

PLU data(non-weighing item) is programmed by following procedure as below.

*If the selected 1st or 2nd label format does not have print area for the PLU items, the item will be skipped automatically or not printed on label

OPERATION	DISPLAY				REMARK
	PT	kg	\$/kg	\$	
[MODE][MODE] [MODE]	S1		PLU	FILE	Enter S mode. Lamp S turns on.
[*]	S1.0	PLU	0	NO SET	Enter PLU programming mode. \$/kg window displays PLU number.
[2][0][0]	S1.0	PLU	200	NO SET	Enter new PLU Number (Ex. 200) you want.
[*]	S1.1	PLU	0.00	PR-KG	Enter PLU programming. Enter unit price.(Ex.5.80 \$ /kg)
[<<] or [>>] [5][8][0]	S1.1	PLU	5.80	PR-PCS	Change Unit price of PLU 200 to non-weighing item.
[*]	S1.2	PLU	DFT	0 LAB FR1	Select Label format for 1 st Label by press [<<] or [>>] key. (T1~T12,S,A,B,C,F1~F8 is available)
[<<] or [>>]	S1.2	PLU	T6	6 LAB FR1	Set the Label format (Ex.T6) by press [6] or [>>] key.
[*]	S1.3	PLU	NO	0 LAB FR2	Select Label format for 2 nd Label by press [<<] or [>>]key. (F1~F8 only)
[<<] or [>>] [*]	S1.4	C01.01		S1 A 100	Enter commodity name.(Ex. "CAKE")

OPERATION	DISPLAY				REMARK
	PT	kg	\$/kg	\$	
[C][A][K][E] [*]	S1.4	C02.01		S1 A 100	Enter the 2 nd line of commodity name.
[*]	S1.5	PLU	EAN	BARCODE	Select the type of BARCODE by press [X] or [>>].(EAN or ITF)
[*]	S1.6	PLU	DFLT	BARCODE	Select barcode format by press [<<] or [>>] key.(Ex.2f5c4i4wD)
[<<] or [>>] [*]	S1.7	PLU	20	FLAG	Set flag data.(Ex.29) The Default Flag Data can be set at SPEC 3 ~ 6 and the Flag data consists of one or two digits, which depends on the selected Barcode type.
[2][9] [*]	S1.8	PLU	00000	IT CODE	Enter item code.(Ex.20020)
[2][0][0][2][0] [*]	S1.9	PLU	00000	EX CODE	No appended item code of PLU 100.
[*]	S1.10	PLU	EAN	ADD OFF	Select EAN ADD-ON or EAN ADD-OFF.(Ex. EAN ADD-OFF)
[*]	S1.12	PLU	997	MG NO	Set the Main Group number.(default MG 997) Enter Main Group No.(Ex.222) Link PLU 200 to Main Group 222.
[2][2][2] [*]	S1.13	PLU	NPRINT	SELL DT	Press [<<] or [>>] key to change whether print sell-by-date. (Ex. Print sell by date)
[<<] or [>>] [*]	S1.14	PLU	0	SELL DT	Set sell-by-date.(Ex.3 days) 3 digits can be set.(0~999)
[3] [*]	S1.15	PLU	NPRINT	SELL TM	Press [<<] or [>>] key to change whether print sell-by-time. (Ex. No print sell by time)
[*]	S1.18	PLU	NPRINT	USED DT	Press [<<] or [>>] key to change whether print used by date.
Set used-by-date, used-by-time	Setting way of used-by-date, used-by-time are same as setting sell-by-date and sell-by-time.

OPERATION	DISPLAY				REMARK
	PT	kg	\$/kg	\$	
[*]	S1.20	PLU	NPRINT	PACK DT	Press [<<] or [>>] key to change whether print packed date.
[<<] or [>>] [*]	S1.21	PLU	0	PACK DT	If necessarily, packed date can set the day after present date. (Ex. 1 day after present day)
[1][*]	S1.22	PLU	NPRINT	PACK TM	Press [<<] or [>>] key to change whether print packed time.
[<<] or [>>] [*]	S1.23	PLU	TIME	PRESENT	Press [<<] or [>>] key to change key-in time or present time.
[<<] or [>>] [*]	S1.24	PLU	0000	PACK TM	Set the packed time. (Ex. 18:00)
[1][8][0][0] [*]	S1.25	PLU	0.00	COST	
[*]	S1.27	PLU	PCS	USYMBOL	Press [<<] or [>>] to select unit symbol. Selection: PCS/FOR/kg/lb/g/NO
[<<] or [>>] [*]	S1.28	PLU	0	QTY	4 digits can be set.(0~9999). (Ex. 10 pcs/PLU)
[1][0] [*]	S1.29	PLU	NO	DISCONT	6 kinds discount type can be selected by press [<<] or [>>] key. (Ex. UNIT PRICE discount)
[<<] or [>>] [*]	S1.34	PLU	NO	MARK DOWN	Change selection by [<<] or [>>]: No mark down/Unit price mark down /Total price mark down/all mark down
[<<] or [>>] [*]	S1.35	PLU	000000	ST DATE	Set discount start day.(Ex.10-01-04, MM-DD-YY)
[1][0][0][1][0][4] [*]	S1.36	PLU	0000	ST TIME	Set discount start time.(Ex. 09:00, HH-MM)
[0][9][0][0] [*]	S1.37	PLU	000000	ED DATE	Set discount end date.(Ex.11-01-04)

OPERATION	DISPLAY				REMARK
	PT	kg	\$ /kg	\$	
[1][1][0][1][0][4] [*]	S1.38	PLU	0000	ED TIME	Set discount end time.(Ex. 09:00)
[0][9][0][0] [*]	S1.40	PLU	0	SMG NUM	Set special message file number.(Ex. Number 1) Special message file 1 is linked to this PLU.
[1][*]	S1.41	PLU	0	ING NUM	Set ingredients file number.(Ex. Number 1) Ingredients file 1 is linked to this PLU.
[1] [PLU]	S1		PLU	ITEM	After finish setting, save it. Back to S mode.

Note1: Press [*] key to next parameter or [-] key to previous parameter.

Note2: The letter before "A" in Total Price display shows the letter font size of the commodity name, and the number after "A" in Total Price display shows the number of letters can be programmed for commodity name.

Note3: The 2 digits after "C" in Weight display shows the line of the commodity name, and the next 2 digits in Weight display shows the position of the cursor.

Note4: The PLU No.1 to No.999999 are available for PLU programming.

Note5: The programmed PLU commodity name are printed on the label or receipt.

Note6: Max.100 letters for commodity name per file are available.

Note7: Each PLU No. must be linked to the exiting Main Group No.(Refer to *3.4 Main Group File*).

3.6.3 PLU [COPY] Function

The programmed PLU data can be easily copied into a new PLU. The function is very useful to save time or avoid mistake for the similar PLU data programming, especially in case of long description of Ingredients.

Example: PLU No.124 is programmed with most data of the PLU No. 100 already in memory.

OPERATION	DISPLAY				REMARK
	PT	kg	\$ /kg	\$	
[MODE][MODE] [MODE]	S1		PLU	FILE	Enter S mode. Lamp S turns on.
[*]	S1.0	PLU	0	NO SET	Enter PLU programming mode. \$ /kg window displays PLU number.
[1][2][4]	S1.1	PLU	124	NO SET	Select PLU 124,enter PLU programming.
[X]	S1.1	PLU	0	COPY	Press [X] key to enter PLU copy function.
[1][0][0] [*]	S1.1	PLU	5.80	PR-KG	Copy PLU 100 data to PLU 124.
[4][8][0] [*]	S1.2	PLU	T6	6 LAB FR1	Unit price of PLU 124 is 4.80 \$ /kg.
[*]	S1.3	PLU	NO	0 LAB FR2	The 1 st Label format is T6.
[*]	S1.4	C01.01	SLICE	S1 A 95	Commodity Name of PLU 124 is “SLICE”.
Press [*] key 5 times	S1.8	PLU	10100	IT CODE	Item code of PLU 124 is 10124.
[1][0][1][2][4]	S1.8	PLU	10124	IT CODE	
[*]	S1.9	PLU	00000	EX CODE	
[PLU]	S1		PLU	FILE	Store the PLU 124 file, back to S mode.

3.6.4 Delete PLU File

OPERATION	DISPLAY				REMARK
	PT	kg	\$ /kg	\$	
[MODE][MODE] [MODE]	S1		PLU	FILE	Enter S mode. Lamp S turns on.
[*]	S1.0	PLU	0	NO SET	Enter PLU programming mode. \$ /kg window displays PLU number.
[1][2][4]	S1.0	PLU	124	NO SET	Select PLU 124.(Ex. Delete PLU No.124)
[-]	S1.0	PLU	DEL ?	Y-C N-T	Press [-] key to delete PLU 124. [C] for Yes, [T] for No.
[C]	S1		PLU	FILE	Delete PLU file No.124, back to S mode.

Note1: Only the programmed PLU file can be deleted.

Note2: In the last operation, pressing [T] key can back to the S Mode without deleting PLU file 124.

3.6.5 Volume Discount & Mark Down print function

Volume Discount function is used to set up special price during a sales period. Shop manager may program the discount price during a sales period, and the Shop manager can avoid sales loss caused by not returning the discount price back to the original price even after the sales period.

Type of Volume Discount

Shop manager can select a discount type from 5 types of volume discount. The formulas of 5 discount type are shown in the following table.

Formula of Discount price

Discount Type	Formula	Example
Free Item ❖ To called up PLU with 0 Unit Price and allow issuing a receipt or label, SPEC 231 must set to " ALLOW " in advance.	Price = 0	Total Price = 0
Unit Price Discount ❖ To select Formula (1) or Formula (2) can be decided by SPEC 124 Setting.	(1) Unit Price = Original Unit Price - Unit Price discount amount. (2) Unit Price = Unit Price discount amount.	Original Unit Price = \$ 10.00 Unit Price discount amount = \$2.00 (1) Unit Price = \$10.00 - \$2.00 = \$8.00 (2) Unit Price = \$2.00
Unit Price % Discount	Unit Price = Original Unit Price x (100% - % Discount)	Original Unit Price = \$ 10.00 % Discount = 20% Unit Price = \$10.00 x (100% - 20%) = \$8.00
Total Price Discount	Total Price = Original Price - Price Discount Amount	Original Total Price = \$10.00 Price Discount Amount = \$2.00 Total Price = \$10.00 - \$2.00 = \$8.00
Total Price % Discount	Total Price = Original Total Price x (100% - % Discount)	Original Total Price = \$10.00 % Discount = 20% Total Price = \$10.00 x (100% - 20%) = \$8.00
Fixed Price Discount	Total Price = Fixed Price Amount	Original Total Price = \$10.00 Fixed Price Amount = \$8.00 Total Price = \$8.00

Mark Down Print Function (How to print discount price)

Mark Down Print function is used to print the discount price as well as the original price with double lines crossed when item is discounted. Mark Down Print function can be selected from the following 4 types, No Mark down / Unit Price Mark down/ Price Mark down / Unit Price & Price Mark down.

Type of Sales price function	Description of Sales Price data on label	
	Unit Price	Total Price
No Mark Down	\$1.50	\$15.00
Unit Price Mark Down	\$ 2.00 1.50	\$15.00
Total Price Mark Down	\$1.50 Refer to Note 1	\$ 20.00 15.00
Unit & Total Price Mark Down	\$ 2.00 1.50	\$ 20.00 15.00

Note 1: Since discount unit price cannot be calculated if Total Price discount is used, it is not able to use Unit Price Mark Down function, when using Total Price discount and Free item discount.

3.7 Memory Status

The function is used for checking the number of existing PLU and remaining programmable PLU.

OPERATION	DISPLAY				REMARK
	PT	kg	\$ /kg	\$	
[MODE][MODE] [MODE]	S1		PLU	FILE	Enter S mode. Lamp S turns on.
[2][0]	S20		MEMORY	STATUS	Select memory status check mode. You can press [\approx] or [\approx] key to select this mode.
[*]	S20.0	PLU	P 7	LF 4544	
[T]	S20		MEMORY	STATUS	Back to S mode.

3.8 Key Assignment

The Preset keys can be used for assignment of PLUs and Function keys to speed up the operation in R mode.

3.8.1 PLU Assignment

PLU Number can be assigned to a preset key to call up PLU data by pressing the assigned preset key on Registration Mode.

For example: Assign PLU Number 100 to Preset Key Number 1.

OPERATION	DISPLAY				REMARK
	PT	kg	\$/kg	\$	
[MODE][MODE] [MODE]	S1		PLU	FILE	Enter S mode. Lamp S turns on.
[4] or [≡] three times	S4		KEY	ASSIGNMENT	Key Assignment mode is MENU 4 in S mode.
[*]	S4.0	PS AS	0	NO SET	Enter PLU assignment mode.
[1][0][0]	S4.0	PS AS	100	NO SET	Enter PLU No.100
[PRESET 1]	S4.0	PS AS	0	NO SET	PLU No.100 had been assigned to Preset Key 1.
[] [C]	S4		KEY	ASSIGNMENT	Back to S mode.

Note1: Non-existing PLU No. can not be assigned.

Note2: If assigning PLU Number 50 to the Preset key No. 1 has been already programmed, the PLU No. 50 will replace the old data of Preset Key No. 1, but PLU Number cannot replace the preset key are already assign for Function Key, Vender Key or Preset Tare.

3.8.2 Function Key Assignment

By assigning the following function keys to Preset keys, the functions can be used by touching the assigned keys

OPERATION	DISPLAY				REMARK
	PT	kg	\$/kg	\$	
[MODE][MODE] [MODE]	S1		PLU	FILE	Enter S mode. Lamp S turns on.
[4] or [≡] three times	S4		KEY	ASSIGNMENT	Key Assignment mode is MENU 4 in S mode.
[*]	S4.0	PS AS	0	NO SET	Enter PLU assignment mode.

OPERATION	DISPLAY				REMARK
	PT	kg	\$/kg	\$	
[*]	S4.1	VR AS	0	NO SET	Enter Vender Key assignment status.
[*]	S4.2	FN AS	0	CLEAR	Enter Function Key assignment status.
[X][X]	S4.0	FN AS	2	-PRICE	Select PRICE DISCOUNT function
[PRESET 25]	S4.2	FN AS	0	CLEAR	PRICE DISCOUNT function had been assigned to Preset Key number 25.
[] [C]	S4		KEY	ASSIGNMENT	Back to S mode.

Notel: Non assigned Preset Key can be set as function key.

3.8.3 Delete Preset Key Assignment

The following operation as below is to delete the Preset Key Assignment for PLU preset key, Function Key and Vender key.

OPERATION	DISPLAY				REMARK
	PT	kg	\$/kg	\$	
[MODE][MODE] [MODE]	S1		PLU	FILE	Enter S mode. Lamp S turns on.
[4] or [≡] three times	S4		KEY	ASSIGNMENT	Key Assignment mode is MENU 4 in S mode.
[*]	S4.0	PS AS	0	NO SET	Enter PLU assignment mode.
[*]	S4.2	FN AS	0	CLEAR	Enter Function Key assignment status.
[PRESET 25]	S4.0	FN AS	DEL ?	Y-C N-T	Enter deleting mode. [C] for Yes, [T] for No.
[C]	S4.0	FN AS	0	CLEAR	
[] [C]	S4		KEY	ASSIGNMENT	Back to S mode.

Notel: Non assigned Preset Key can not be cleared.

Note2: In the last operation, pressing [T] key can back to Assigned key clear mode and do not clear the assigned key

3.9 Shop Name File

Shop Name data will be printed on Label or Receipt can be programmed in this file. The maximum number of characters possible to enter varies according to the size of print area or character size entry. Up to 32 Shop Names can be programmed with each 3 lines as maximum and number of line is depends on the Character Size entry.

The default Shop Name print on label can be set at **SPEC 46** & print centering of shop name on label can be select at **SPEC 250** and default Shop Name print on Receipt can be set at **SPEC47** & printing position can be select at **SPEC251**.

3.9.1 Program Shop Name File

At Programming Mode, select Shop Name programming mode and then enter new Shop Name number (Ex. 1) programming mode.

OPERATION	DISPLAY				REMARK
	PT	kg	\$ /kg	\$	
[MODE][MODE] [MODE]	S1		PLU	FILE	Enter S mode. Lamp S turns on.
[5] or [↵] four times	S5		SHOP	NAME FILE	Shop name File mode is MENU 5 in S mode.
[*]	S5.0	SHOP	0	NO SET	Enter Shop Name File programming mode.
[1][*]	S5.1	S01.01		S1 A 100	Enter shop name code.(Ex.No.1)
[SIZE][D][I][G][I][SP][S][H][O][P]	S5.1	S01.10	SHOP	S2 A 76	Press [SIZE] key to change font size of the shop name. Enter the shop name .(Ex. “DIGI SHOP”)
[*]	S5.1	S02.01		S1 A 100	Program 2 nd line of this shop name.
[T][E][L][E].....	S5.1	S02.13		S1 A 88	Enter shop name for the 2 nd line.(Ex. “TEL:57234888”)
[PLU]	S5		SHOP	NAME FILE	Store Shop Name File 1,Back to S mode.

3.9.2 Delete Shop Name File

At Shop Name programming mode, enter existing Shop Name Number (Ex. 1) to be deleted.

OPERATION	DISPLAY				REMARK
	PT	kg	\$ /kg	\$	
[MODE][MODE] [MODE]	S1		PLU	FILE	Enter S mode. Lamp S turns on.
[5] or [≡] four times	S5		SHOP	NAME FILE	Shop name File mode is MENU 5 in S mode.
[*]	S5.0	SHOP	0	NO SET	Enter Shop Name File programming mode.
[1]	S5.0	SHOP	1	NO SET	Enter shop name file 1.(Ex. No.1)
[-]	S5.0	SHOP	DEL ?	Y-C N-T	Enter deleting mode. [C] for Yes, [T] for No.
[C]	S5		SHOP	NAME FILE	Delete Shop Name File 1,back to S mode.

Note1: If you want to cancel the deletion, press [T] key to exit.

Note2: Non-existing Shop Name File can not be deleted.

3.10 Advertisement File

Advertisement message is the sales promotional description on the label, such as “FOR BARBECUE” or “FRESH”. Advertisement message is printed in the print area of the Commodity Name. If Commodity Name occupies all of the print area, there will be no room for the Advertisement Message and it will therefore not be printed. Maximum 2 lines can be programmed for each Advertisement Message and up to 64 (Advertisement # 1~64) advertisement messages are available.

To print advertisement message on a label, **[ADVERTISEMENT]** Function Key must be assigned to a preset key in advance.

Note: Advertisement message print on all label can be set at **SPEC 96**, printing **position** can be set at **SPEC 14** and printing **method** can be set at **SPEC 15**.

3.10.1 Program Advertisement File

At Programming Mode, select Advertisement programming mode and then enter new Advertisement number (Ex. 1) programming mode.

OPERATION	DISPLAY				REMARK
	PT	kg	\$/kg	\$	
[MODE][MODE] [MODE]	S1		PLU	FILE	Enter S mode. Lamp S turns on.
[6] or [≡] five times	S6		ADVER	MESSAGE	Select advertisement file programming mode.
[*]	S6.0	ADVER	0	NO SET	Enter advertisement File programming mode.
[1][*]	S6.1	A01.01		S1 A 100	Enter the advertisement File No.1(Ex.No.1)
[T][H][A][N][K][SP] [Y][O][U]	S6.1	A01.10	K YOU	S1 A 91	Enter the advertisement as the same procedures as Commodity Name Entry. (Ex. “THANK YOU”)
[SIZE]	S6.1	A01.10	K YOU	S2 A 76	Press [SIZE] key to change font size of the advertisement file.
[SIZE]...[SIZE]	S6.1	A01.10	K YOU	L5 A 21	Change font size to L5. (S1~S5; M1~M5; L1~L5)
[*]	S6.1	A02.01		S1 A 100	Program 2 nd line of this advertisement file.
[PLU]	S6		ADVER	MESSAGE	Store Advertisement File 1,back to S mode.

Note! Max.2 line per file are available, max.100 letters per line are available. (letters per line depends on font size)

3.10.2 Delete Advertisement File

At Advertisement programming mode, enter existing Advertisement Number (Ex. 1) to be deleted.

OPERATION	DISPLAY				REMARK
	PT	kg	\$ /kg	\$	
[MODE][MODE] [MODE]	S1		PLU	FILE	Enter S mode. Lamp S turns on.
[6] or [≡] five times	S6		ADVER	MESSAGE	Select advertisement file programming mode.
[*]	S6.0	ADVER	0	NO SET	Enter advertisement File programming mode.
[1]	S6.0	ADVER	1	NO SET	Enter advertisement File 1.(Ex. No.1)
[-]	S6.0	ADVER	DEL ?	Y-C N-T	Enter deleting mode. [C] for Yes, [T] for No.
[C]	S6		ADVER	MESSAGE	Delete advertisement File 1,back to S mode.

Note1: If you want to cancel the deletion, press [T] key to exit.

Note2: Non-existing Advertisement File can not be deleted

3.11 Vender File

Vender file is used for programming names of operators. Maximum 16 characters can be entered per Vender name. A programmed Vender number can be assigned to a preset key. The Vender Number or Name (Depend on Spec 21 setting) will be printed on the label, if selected label format with print area for Vender Number and the programmed Vender name can be printed on receipt when **SPEC 21** set to **NAME**.

3.11.1 Program Vender File

OPERATION	DISPLAY				REMARK
	PT	kg	\$ /kg	\$	
[MODE][MODE] [MODE]	S1		PLU	FILE	Enter S mode. Lamp S turns on.
[7] or [≡] six times	S7		VENDER	FILE	Select Vender file programming mode.
[*]	S7.0	CLERK	0	NO SET	Enter Vender File programming mode.
[1][*]	S7.1	CLERK	1	NAME 0	Select vender key.(Ex. V1) Program operator name for Vender 1.
[M][I][K][E]	S7.1	CLERK	MIKE	NAME 4	Enter operator name for V1.(Ex. "MIKE")
[PLU]	S7		VENDER	FILE	Store Vender File V1,back to S mode.

Note: V1 – V99 can be programmed

3.12 Program Date And Time

The built-in clock system can automatically work once they are set. Date (Month/Day/Year): 2 digits for each part; Time (Hour/Minute): 2 digits for each part.

OPERATION	DISPLAY				REMARK
	PT	kg	\$/kg	\$	
[MODE][MODE] [MODE]	S1		PLU	FILE	Enter S mode. Lamp S turns on.
[8] or [≡] seven times	S8		DATE	AND TIME	Select Date and Time programming mode.
[*]	P8.0	DATE	010100	MMDDYY	Enter Date and Time programming mode.
[0][8][1][9][0][4][*]	P8.1	TIME	0000	HHMM	Set Month 08, Day 19 and Year 04. (Ex. 2004-08-19)
[9][0][0][*]	S8		DATE	AND TIME	Set Hour 9,Minute 05. Store Date and Time, back to S mode.

3.13 Special Message File

Special Message can be used as a description on the label such as receipt, which can be assigned in each PLU. Since standard format does not have a print area set for Special Message, Special Message cannot be printed when using these formats. To print Special Message on the label, it is required to use a Free Format with a Special Message print area programmed. Maximum 16 special messages can be programmed with each up to 8 programmable lines. Number of line is depends on the size of the print area or Character Size entry. The default Special Number print on Receipt can be set at **SPEC 112** and printing position can be set at **SPEC 125**.

Note: If SPEC 43 set to RECEIPT, maximum 8 lines can be programmable for each Special Message Number and without select a required Free Format.

3.13.1 Program Special Message File

At Programming Mode, select Special Message programming mode and then enter new Special Message number (Ex. 1) programming mode. *For edit, enter existing Special Message number.

OPERATION	DISPLAY				REMARK
	PT	kg	\$/kg	\$	
[MODE][MODE] [MODE]	S1		PLU	FILE	Enter S mode. Lamp S turns on.
[9] or [≡] eight times	S9		SP	MESSAGE	Select special message file programming mode.
[*]	S9.0	SP MG	0	NO SET	Enter special message File programming mode.
[1][*]	S9.1	M01.01		S1 A 100	Enter the special message File No.1.(Ex.No.1)
[M][A][D][E][SP][I][N]][SP][C][H][I][N][A]	S9.1	M01.14	CHINA	S1 A 87	Enter the special message File as the same procedures as Commodity Name Entry. (Ex. “MADE IN CHINA”)
[SIZE]	S9.1	M01.14	CHINA	S2 A 72	Press [SIZE] key to change font size of the special message File.
[SIZE]...[SIZE]	S9.1	M02.01	CHINA	M3 A 62	Change font size to M3. (S1~S5; M1~M5; L1~L5)
[*]	S9.1	M02.01		S1 A 56	Program 2 nd line of this special message File.
[PLU]	S9		SP	MESSAGE	Store special message File 1,back to S mode.

3.13.2 Delete Special Message File

At Special Message programming mode, enter existing Special Message Number (Ex. 1) to be deleted.

OPERATION	DISPLAY				REMARK
	PT	kg	\$ /kg	\$	
[MODE][MODE] [MODE]	S1		PLU	FILE	Enter S mode. Lamp S turns on.
[9] or [≡] eight times	S9		SP	MESSAGE	Select special message file programming mode.
[*]	S9.0	SP MG	0	NO SET	Enter special message File programming mode.
[1]	S9.0	SP MG	1	NO SET	Enter special message File 1.(Ex. No.1)
[-]	S9.0	SP MG	DEL ?	Y-C N-T	Enter deleting mode. [C] for Yes, [T] for No.
[C]	S9		SP	MESSAGE	Delete special message File 1,back to S mode.

Note1: If you want to cancel the deletion, press [T] key to exit.

Note2: Non-existing Special Message File can not be deleted.

3.14 Ingredient File

Ingredients data programmed in this Master Ingredient file can be printed on the Free Format (F1-F99) with ingredient print area. The size of print area will decide the numbers of lines and characters of every line. Maximum 15 lines can be programmed for each Master ingredient data and up to 16 Master Ingredients data can be programmed in this file.

Note: Maximum 39 lines can be programmed for each Master Ingredient data when SPEC 43 set to 0.

3.14.1 Program Ingredient File

At Programming Mode, select Ingredient programming mode and then enter new Ingredient number (Ex. 1) programming mode. *For edit, enter existing Ingredient number.

OPERATION	DISPLAY				REMARK
	PT	kg	\$ /kg	\$	
[MODE][MODE] [MODE]	S1		PLU	FILE	Enter S mode. Lamp S turns on.
[10] or [≡] nine times	S10		INGR	FILE	Select Ingredient file programming mode.
[*]	S10.0	INGR	0	NO SET	Enter Ingredient File programming mode.
[1][*]	S10.1	G01.01		S1 A 100	Enter the Ingredient File No.1.(Ex.No.1)
[S][U][G][A][R]	S10.1	G01.06	SUGAR	S1 A 100	Enter the Ingredient File as the same procedures as Commodity Name Entry. (Ex. "SUGAR")
[SIZE]	S10.1	G01.06	SUGAR	S2 A 95	Press [SIZE] key to change font size of the Ingredient File.
[*]	S10.1	G02.01		S1 A 100	Program 2 nd line of this Ingredient File.
[F][L][O][U][R]	S10.1	G02.06	FLOUR	S1 A95	
[PLU]	S10		INGR	FILE	Store Ingredient File 1,back to S mode.

3.14.2 Delete Ingredient File

At Ingredient programming mode, enter existing Ingredient Number (Ex. 1) to be deleted.

OPERATION	DISPLAY				REMARK
	PT	kg	\$ /kg	\$	
[MODE][MODE] [MODE]	S1		PLU	FILE	Enter S mode. Lamp S turns on.
[10] or [≡] nine times	S10		INGR	FILE	Select Ingredient file programming mode.
[*]	S10.0	INGR	0	NO SET	Enter Ingredient File programming mode.
[1]	S10.0	INGR	1	NO SET	Enter Ingredient File 1.(Ex. No.1)
[-]	S10.0	INGR	DEL ?	Y-C N-T	Enter deleting mode. [C] for Yes, [T] for No.
[C]	S10		INGR	FILE	Delete Ingredient File 1,back to S mode.

Note1: If you want to cancel the deletion, press [T] key to exit.

Note2: Non-existing Ingredients File can not be deleted.

3.15 Text File

Maximum 20 Texts are available (Text 1~16 are for Item label and text 17~20 are for Total label). Text is used for printing the fixed data on label such as “Unit Price”, “packed date”. Text cannot be printed when using standard format since they do not have any text print area set. You must use a Free Format with a Text print area programmed. Maximum 2 lines per text can be programmed and number of line is depends on the size of print area of the selected label format or Character Size entry.

Note: Print Text 5 to 16 on Total label can be set at **SPEC 332** setting.

3.15.1 Program Text File

At Programming Mode, select Text programming mode and then enter new Text number (Ex. 1) programming mode. *For edit, enter existing Text number.

OPERATION	DISPLAY				REMARK
	PT	kg	\$/kg	\$	
[MODE][MODE] [MODE]	S1		PLU	FILE	Enter S mode. Lamp S turns on.
[11] or [≡] ten times	S11		TEXT	FILE	Select Text file programming mode.
[*]	S11.0	TEXT	0	NO SET	Enter Text File programming mode.
[1][*]	S11.1	T01.01		S1 A 100	Enter the Text File No.1.(Ex.No.1)
[P][A][C][K][A][G][E]	S11.1	T01.08	CKAGE	S1 A 93	Enter the Text File as the same procedures as Commodity Name Entry. (Ex. “PACKAGE”)
[SIZE]	S11.1	T01.08	CKAGE	S2 A 78	Press [SIZE] key to change font size of the Ingredient File.
[SIZE]...[SIZE]	S11.1	T01.08	CKAGE	S5 A 53	Change font size to S5. (S1~S5; M1~M5; L1~L5)
[*]	S11.1	T02.01		S1 A 56	Program 2 nd line of this Ingredient File.
[D][A][T][E]	S11.1	T02.05	DATE	S1 A 52	
[PLU]	S11		TEXT	FILE	Store Text File 1,back to S mode.

3.15.2 Delete Text File

At Text programming mode, enter existing Text Number (Ex. 1) to be deleted.

OPERATION	DISPLAY				REMARK
	PT	kg	\$ /kg	\$	
[MODE][MODE] [MODE]	S1		PLU	FILE	Enter S mode. Lamp S turns on.
[11] or [≡] ten times	S11		TEXT	FILE	Select Text file programming mode.
[*]	S11.0	TEXT	0	NO SET	Enter Text File programming mode.
[1]	S11.0	TEXT	1	NO SET	Enter Text File 1.(Ex. No.1)
[-]	S11.0	TEXT	DEL ?	Y-C N-T	Enter deleting mode. [C] for Yes, [T] for No.
[C]	S11		TEXT	FILE	Delete Text File 1,back to S mode.

Note1: If you want to cancel the deletion, press [T] key to exit.

Note2: Non-existing Text File can not be deleted.

3.16 Free Format File

The Free Format enables you to design your own label format, by setting print angles, print positions, character size and other programmable items. You can create a new format by copying an existing label format and use it as a base or make a totally new label format.

3.16.1 General Information

Label format within the following height and width can be created.

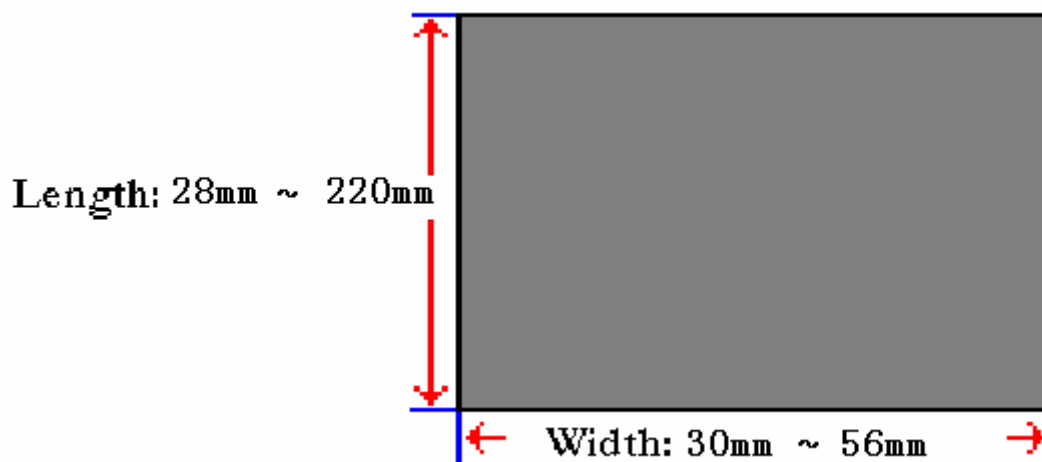

- Up to 99 Free Formats can be stored in the memory, apart from the other 16 standard formats.
- Standard format can be used as a basic format for creating a new format.
- Print position of each item is programmed using "mm".
- One Item label or one Total label is available for each Free Format number (F1~F99).
- 4 Print Angles can be set for all item data: 0, 90, 180 and 270 degrees.

3.16.2 Print Area, Print Position and Print Angles

All changeable item data should be programmed 8mm above the bottom of the label. The bottom 8 mm of the label should be used for invariable data such as shop name, since this area is printed when issuing the last label. Please do not program any item closer than 1mm to the edges of the label.

The print position of each item is determined by setting the interval from "0" point (X=0, Y=0) to the base position of the programmed item. X and Y values need to be entered by "mm".

Print Area

The item data cannot be printed at the bottom 10 mm of labels. Pre-print data such as shop name or logo data is programmed at the bottom 10mm. Also the item data should not be printed within 1mm from the left edge or the right edge of the label as the following drawing shows.

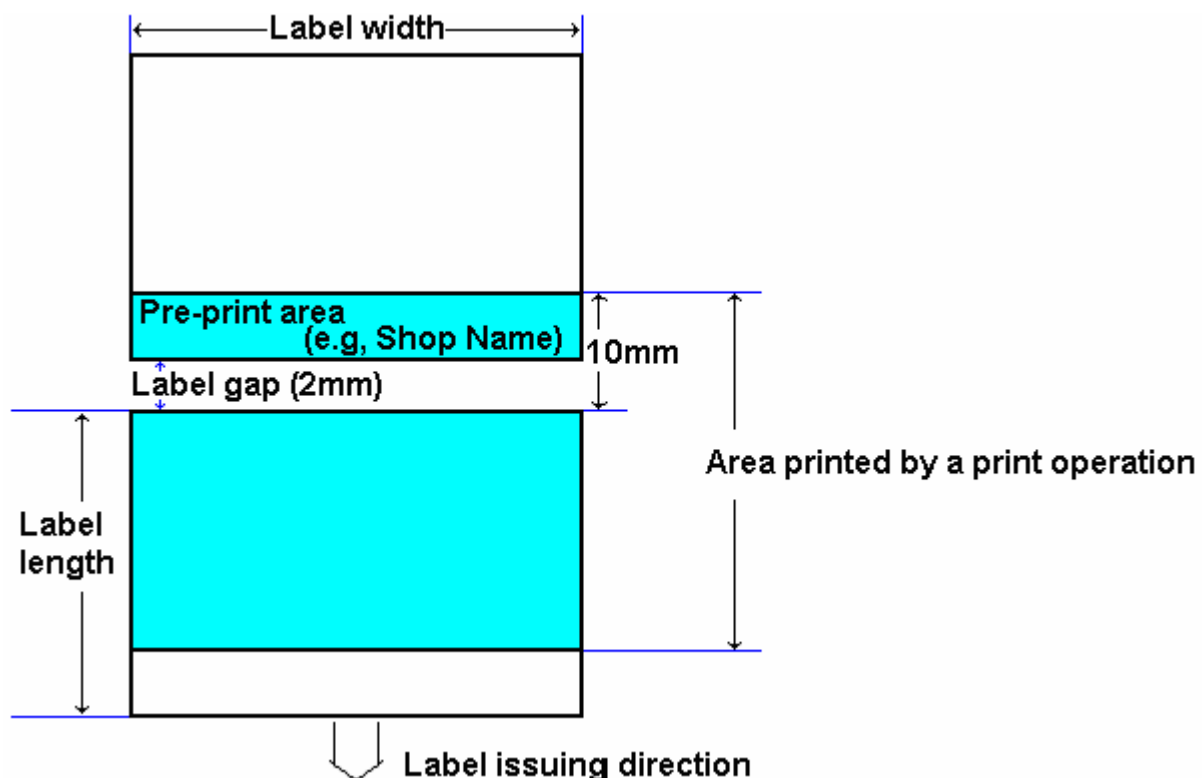

Print Position

The printing position of each item data is decided by setting the distance from 0 point ($X=0, Y=0$) to the base position (X value, Y value).

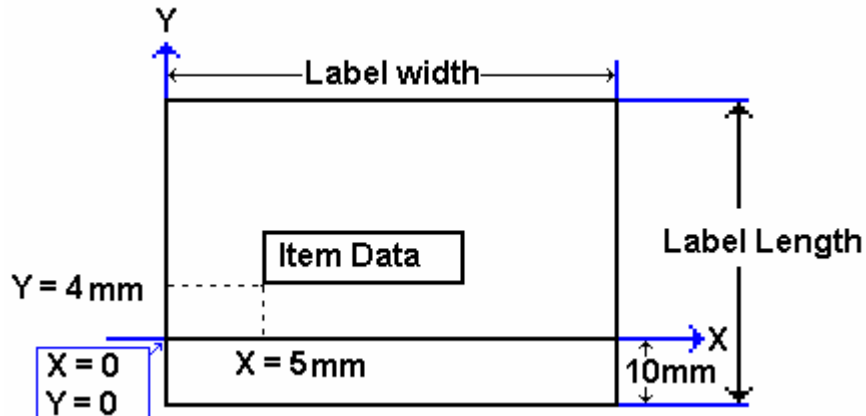

Print Angle

Print angle of each Print Item can be selected from 4 different angles, 0 degree, 90 degree, 180 degree, and 270 degree. A whole format base or each Item Data-base may set print angle. According to the selected print angle, the status of print position differs as the following samples.

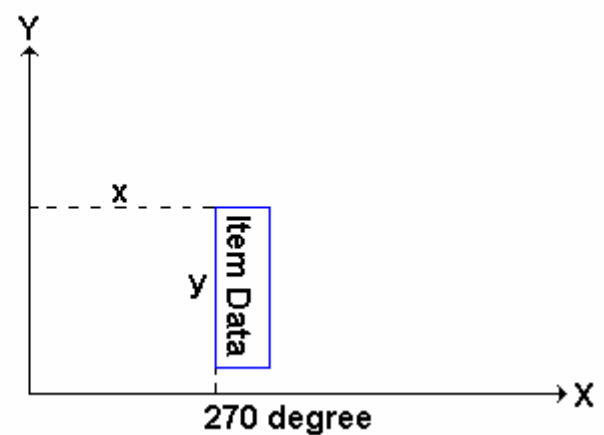
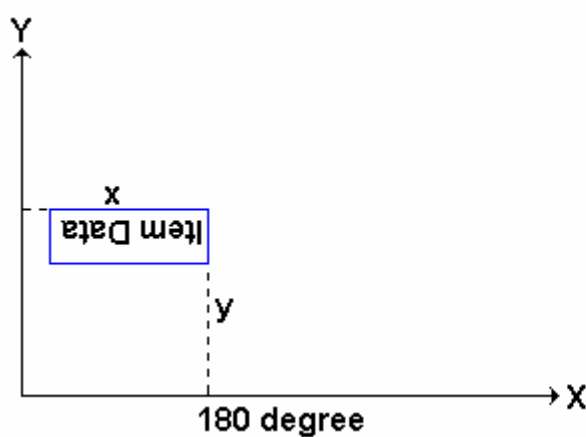
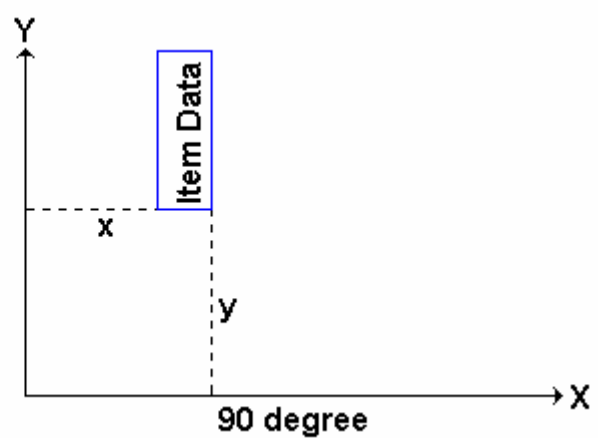
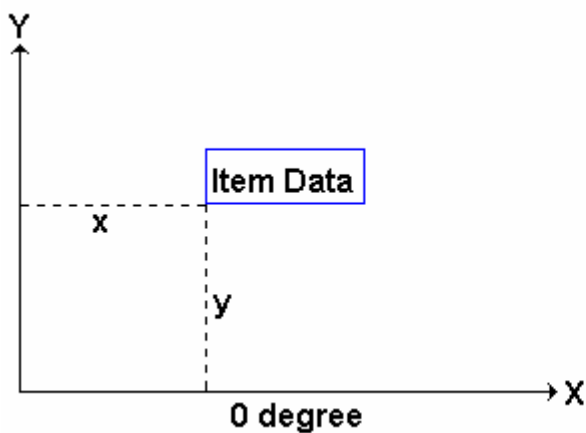

3.16.3 Programming Parameter Of Print Items

Print Item for Item Label

Up to 82 different item data can be programmed in Item Label Format and is used for printing at Manual mode and pre-pack mode.

Item Data	Type	Display	Item Data	Type	Display
1. PLU NO	1	PLU _{no}	45. PRICE BEFORE DISCOUNT	1	
2. PRICE (-TAX)	1	PRICE	46. UNIT PRICE BEFORE DISCOUNT	1	
3. UNIT PRICE	1	UN PR	47 ~ 56.IMAGE 1 ~ IMAGE 10	2	IMG??
4. WEIGHT	1	WT	57. AVERAGE PRICE	1	
5. QUANTITY	1	QTY	58. AVERAGE WEIGHT	1	
6. PACKED DATE	1	PDATE	59. BONUS POINT	1	BONUS
7. PACKED TIME	1	PTIME	60. EURO UNIT PRICE	1	EUR U
8. COMMODITY	2	COMM	61. EURO TOTAL PRICE	1	EUR T
9. QUANTITY UNIT	1	QTYSY	62. EURO CALULATION	1	EUR C
10. SELL DATE	1	SDATE	63. DUPLICATE TOTAL PRICE	1	
11. SELL TIME	1	STIME	64. DUPLICATE UNIT PRICE	1	
12. BARCODE	3	BARCD	66. BORN COUNTRY	1	BORN
13. SHOP NAME	2	SHOPN	67. FATTEN COUNTRY	1	FAT
14. DISCOUNT VALUE	1	DISCT	68. SLAUGHTER HOUSE	1	SLAUG
15. USED DATE	1	UDATE	69. CUTTING HALL	1	CUT H
16. LOGO	2	LOGO	70. REFER NO	1	FEF D
17. MAIN GROUP CODE	1	MG CD	71. ORIGIN	1	ORIGI
18. DEPARTMENT CODE	1	DEPT	72. TEMPERATURE	1	TEMP
19. SCALE NUMBER	1	SCLNO	73. MULTI BARCODE 1	3	M1BAR
20. INGREDIENT	2	INGR	74. MULTI BARCODE 2	3	M2BAR
21. SPECIAL MESSAGE	2	SP MG	75. SERIAL NO	1	
22. FRAME 1	4	FRM 1	76. GROSS WEIGHT	1	
23. FRAME 2	4	FRM 2	77. REWRAP	1	
24. TARE	1	TARE	78. KIND	1	
25. CLERK	1	CLERK	79. CATEGORY	1	
26 ~ 41. TEXT 1 ~ TEXT 16	2	TXT??	80. BREED	1	
42. PRICE (+ TAX)	1	PRTAX	81. CONTACT	1	
43. TAX RAGE	1	TAX R	82. GTIN	1	
44. PLACE	2	PLACE			

Note: When SPEC 158 set to "ENABLE" the Screen of Item no.2 will change to "**DISCOUNT PRICE**" & item Number 3 change to "**DISCOUNT UNIT PRICE**", and Item Number of 45 & 46 will appears.

Print Item for Total Label

Up to 28 different item data can be programmed in Total Label Format and is used for printing multiple transaction labels for counter sales at Manual mode, Sub-Total and Grand Total at Pre-pack mode.

Item Data	Type	Display	Item Data	Type	Display
1. PLU NO	1	PLU _{no}	15. PRICE (- TAX)	1	P-TAX
2. PACK DATE	1	PDATE	16. EXCLUDED TAX AMOUNT	1	ATX
3. WEIGHT	1	WT	17. INCLUDED TAX AMOUNT	1	VTX
4. QUANTITY	1	QTY	18. EURO TOTAL PRICE	1	ERUO
5. QUANTITY UNIT	1	QTYSY	19. USED DATE	1	UPDATE
6. PRICE (+ TAX)	1	PRTAX	20. BORN COUNTRY	1	BORN
7. PACKED TIME	1	PTIME	21. FATTEN COUNTRY	1	FAT
8. TOTAL TITLE	1	TOTAL	22. SLAUGHTER HOUSE	1	SLAUG
9. BARCODE	3	BARCD	23. CUTTING HALL	1	CUT H
10. CLERK	1	CLERK	24. REFER DATE	1	REF D
11. TEXT 17	2	TXT17	25. ORIGINAL COUNTRY	1	ORIGI
12. TEXT 18	2	TXT18	26. MULTI BARCODE 1	3	M1BAR
13. TEXT 19	2	TXT19	27. MULTI BARCODE 2	3	M2BAR
14. TEXT 20	2	TXT20	28. SERIAL NO	1	

Programmable Data Type

Programmable data	<u>Type 1</u>	<u>Type 2</u>	<u>Type 3</u>	<u>Type 4</u>
X position	YES	YES	YES	YES
Y position	YES	YES	YES	YES
Angle	YES	YES	YES	NO
Status	YES	YES	YES	YES
Character Size	YES	NO	NO	NO
Width	NO	YES	NO	NO
Height	NO	YES	YES	NO
Thickness	NO	NO	NO	YES

3.16.4 Free Format Entry

At Programming Mode, select Free Format programming mode and then enter new Free Format number (Ex. 1) programming mode. *For edit, enter existing Free Format number.

Basic Setting: (width, height, angle and label type)

OPERATION	DISPLAY				REMARK
	PT	kg	\$ /kg	\$	
[MODE][MODE] [MODE]	S1		PLU	FILE	Enter S mode. Lamp S turns on.
[1][2]	S12		FREE	FORMAT	Select Free Format setting programming mode.
[*]	S12.0	FREE	0	1-99	Enter Free Format setting programming mode. Select Free Format File Number.
[1][*]	S12.1	LABEL	0	WT MM	Enter the Free Format File No.1.(Ex.No.1)
[4][8][*]	S12.2	LABEL	0	HT MM	Enter Label print width.(Ex.48mm)
[3][5][*]	S12.3	LABEL	0	DG ANGLE	Enter Label print height.(Ex.35mm)
[<<] or [>>]	S12.3	LABEL	90	DG ANGLE	[<<] or [>>] key can change the selection of label angle. (0,90,180,270 degree)
[*]	S12.4	LABEL	ITEM	LABEL	Label angle is turned 90 degree.
[<<] or [>>]	S12.4	LABEL	TOTAL	LABEL	Select label type. (Item Label; Total Label)
[*]	S12.5	PLUno	1	F ITEM	Enter item setting. Refer to Base Type 1 to 4 setting.

Base Type 1:

Item data in Data Base Type1 are Numeric data or Fixed data. The print position of item data can be programmed by setting X / Y value, Print angle and Character size.

Item Label PLU No., Price, Unit Price, Weight, Quantity, Packed date, Packed Time, Quantity Symbol, Sell by date, Sell by time, Discount Price, Used by date, MG No., Dept. No., Scale No., Tare Weight, Clerk No., and Text data.

Total Label PLU No., Packed date, Total Weight, Total quantity, Quantity symbol, Total Price, Packed time, Letter of **TOTAL**, Clerk No., and Text data.

OPERATION	DISPLAY				REMARK
	PT	kg	\$ /kg	\$	
Continued from the procedure Basic Setting: (width, height, angle and label type)					
	S12.5	PLUno	1	F ITEM	Item setting: PLU No.
[*]	S12.5	PLUno	0	X MM	Enter X value.(Ex.1mm)
[1][*]	S12.5	PLUno	0	Y MM	Enter Y value.(Ex.1mm)
[1][*]	S12.5	PLUno	0	DG ANGLE	Select print angle.(Ex.90 degree)
[>>][*]	S12.5	PLUno	0	STATUS	Enter print status.(Ex. All item print)
[7][*]	S12.5	PLUno	S1	CHAR SIZE	Select the character size.(Ex. S5)
[>>] four times	S12.5	PLUno	S5	CHAR SIZE	[<<] or [>>] key can change the selection of the character size. (S1~S5; M1~M5; L1~L5)
[*]	S12.5	PLUno	1	F ITEM	Enter next item setting.

Note 1: STATUS TYPE: 0: NO Print 3: Weighing Item 4: Non-weighing Item 7: All Item Print

Note 2: Up to 41 different item data can be programmed in Item Label Format and is used for printing at Manual Mode and Pre-pack Mode.

Note 3: Up to 14 different item data can be programmed in Total Label Format and is used for printing multiple transaction labels for counter sales at Manual Mode, Sub-Total and Grand Total at Pre-pack Mode.

Note 4: There are two ways to select the Item Data in Free Format programming by using different keys such as:

- Enter the Item data number key.
- Press [X] key or [-] key to search the Item data.

Base Type 2

Item data in Base Type 2 are Alpha-numeric data. The print position of item data can be programmed by setting the max. print area , X / Y value, width of print area from X value, height of print area from Y value and print angle.

Item Label. Commodity Name, Shop Name, Logo, Ingredient, and Special Message.

OPERATION	DISPLAY				REMARK
	PT	kg	\$ /kg	\$	
Continued from the procedure Basic Setting: (width, height, angle and label type)					
	S12.5	SHOPN	13	F ITEM	Item setting: Shop name.
[*]	S12.5	SHOPN	0	X MM	Enter X value.(Ex.10mm)
[1][0][*]	S12.5	SHOPN	0	Y MM	Enter Y value.(Ex.1mm)
[1][*]	S12.5	SHOPN	0	DG ANGLE	Select print angle.(Ex.180 degree)
[>>][>>][*]	S12.5	SHOPN	0	WT MM	Enter width value. The width of shop name printing area is 20mm.(Ex. 20mm)
[2][0][*]	S12.5	SHOPN	0	HT MM	Enter height value. The height of shop name printing area is 15mm.(Ex. 15mm)
[1][5][*]	S12.5	SHOPN	0	STATUS	Enter print status.(Ex. All item print)
[7]	S12.5	SHOPN	7	STATUS	The status of shop name printing area is all item printing.
[*]	S12.5	SHOPN	13	F ITEM	Enter next item setting.

Base Type 3

Item data in Data Base 3 is Barcode data. The print position of bar-code data can be programmed by setting X / Y value, width of Barcode from X value, height of Barcode from Y value and print angle.

OPERATION	DISPLAY				REMARK
	PT	kg	\$/kg	\$	
Continued from the procedure Basic Setting: (width, height, angle and label type)					
	S12.5	BARCD	12	F ITEM	Item setting: Barcode.
[*]	S12.5	BARCD	0	X MM	Enter X value.(Ex.5mm)
[5][*]	S12.5	BARCD	0	Y MM	Enter Y value.(Ex.20mm)
[2][0][*]	S12.5	BARCD	0	DG ANGLE	Select print angle.(Ex.90 degree)
[>>][*]	S12.5	BARCD	0	HT MM	Enter height value. The height of shop name printing area is 25mm.(Ex. 25mm)
[2][5][*]	S12.5	BARCD	0	STATUS	Enter print status.(Ex. All item print)
[7]	S12.5	BARCD	7	STATUS	The status of BARCODE printing area is all item printing.
[*]	S12.5	BARCD	12	F ITEM	Enter next item setting.

Base Type 4

Item data in Data Base 4 is Frame data. The print position of Frame data may be programmed by setting X value, Y value, X1 value, Y1 value [the opposite point against the point (X,Y) on a diagonal line], and line weight.

OPERATION	DISPLAY				REMARK
	PT	kg	\$ /kg	\$	
Continued from the procedure Basic Setting: (width, height, angle and label type)					
	S12.5	FRM 1	22	F ITEM	Item setting: Frame 1.
[*]	S12.5	FRM 1	0	X MM	Enter X value.(Ex.10mm)
[1][0][*]	S12.5	FRM 1	0	Y MM	Enter Y value.(Ex.1mm)
[1][*]	S12.5	FRM 1	0	X1 MM	Enter X1 value. The X1 of frame 1 printing area is 20mm.(Ex. 20mm)
[2][0][*]	S12.5	FRM1	0	Y1 MM	Enter Y1 value. The Y1 of frame 1 printing area is 15mm.(Ex. 15mm)
[1][5][*]	S12.5	FRM 1	0	STATUS	Enter print status.(Ex. All item print)
[7][*]	S12.5	FRM 1	0	T MM	Enter line weight. The line weight of frame 1 printing area is 2mm.(Ex. 2mm)
[2][*]	S12.5	FRM 1	22	F ITEM	Enter next item setting.

3.16.5 Free Format Copy Function

At Free Format programming mode, Select Copy existing Label Format and then select the existing label format you want to be copy (Ex. T7) and go to next selection.

OPERATION	DISPLAY				REMARK
	PT	kg	\$ /kg	\$	
	S1		PLU	FILE	Enter S mode.
[1][2][*]	S12.0	FREE	0	1-99	Enter X value.(Ex.10mm)
[1]	S12.0	FREE	1	1-99	Enter the Free Format File No.1.(Ex.No.1)
[X]	S12.0	FREE	NO 0	COPY	Press [X] key to enter free format copy function.
[7] or [<<] and [>>]	S12.0	FREE	T7 7	COPY	Press [7] or [<<] and [>>] to select the existing label format you want to be copy.(Ex. T7)
[*][PLU]	S12		FREE	FORMAT	Store the free format file 1, back to S mode.

Note1: Another way to select the existing label format to copy by press [<<] Key or [>>] Key.

3.16.6 Free Format Delete Function

The Free Format Label cannot be deleted when the label is linked to existing PLU file.

At Free Format programming mode, enter existing Free Format Number (Ex. 1) to be deleted.

OPERATION	DISPLAY				REMARK
	PT	kg	\$ /kg	\$	
	S12.0	FREE	0	1-99	Enter Free Format programming mode.
[1]	S12.0	FREE	1	1-99	Enter free format file number 1.
[-]	S12.0	FREE	DEL ?	Y-C N-T	Enter delete mode. [C] for Yes,[T] for No.
[C]	S12.0		FREE	FORMAT	Delete free format file 1, back to S mode.

Note1: If you want to cancel the deletion, press [T] key to exit.

Note2: Non-existing Free Format File can not be deleted.

3.16.7 Sample of program a format by modifying the existing format

You can create your desired label format by copying an existing format and modifying it to your needs.

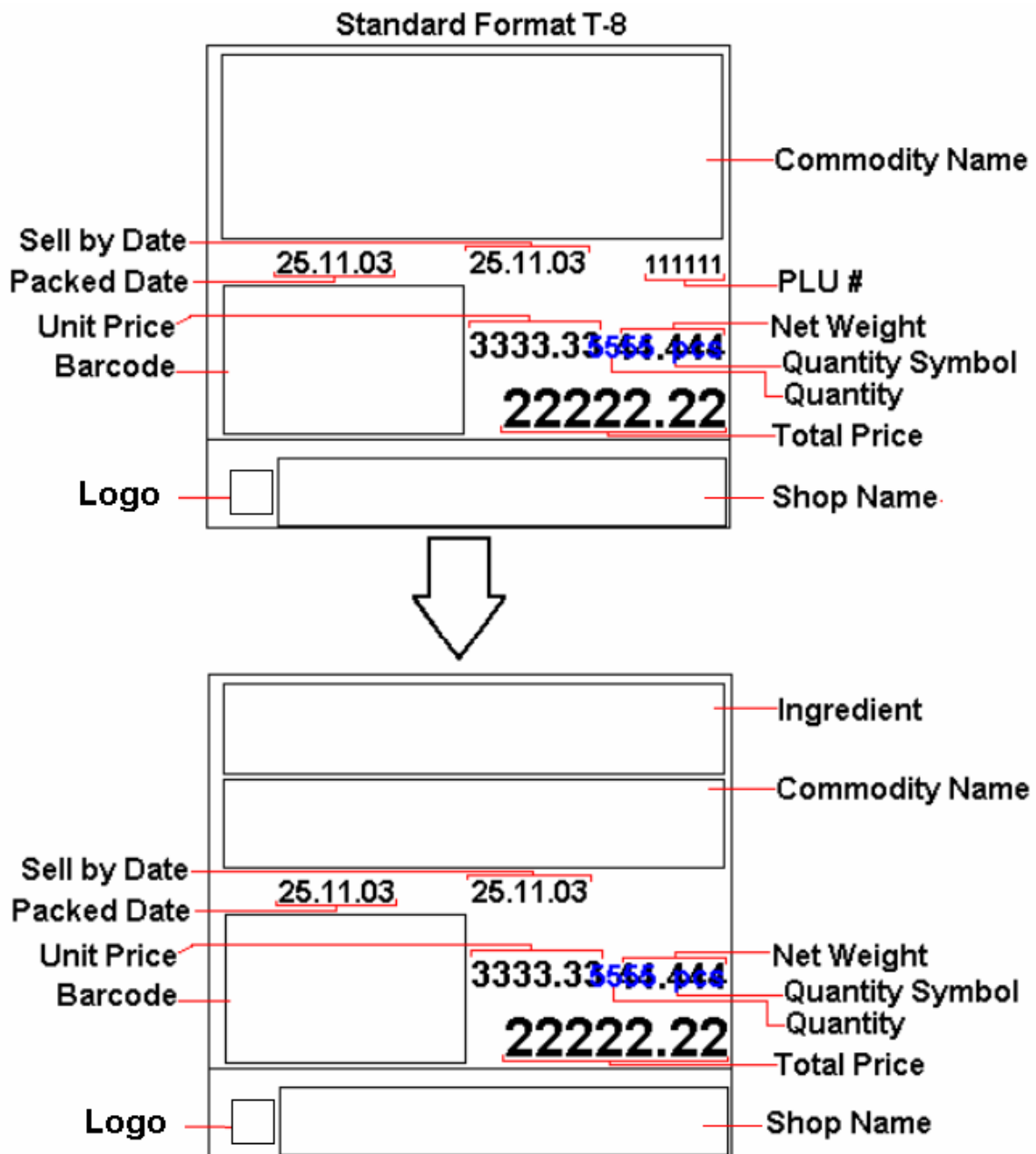

Following is the example on how to customize standard format T8 to your needs. E.g. Add an ingredient text and remove the PLU # from the standard Item Label Format

OPERATION	DISPLAY				REMARK
	PT	kg	\$/kg	\$	
	S12		FREE	FORMAT	At Free Format program mode
[*]	S12.0	FREE	0	1-99	Enter Free Format setting programming mode. Select Free Format File Number.
[8]	S12.0	FREE	8	1-99	Enter the Free Format File No.1.(Ex.No.8)
[X]	S12.0	FREE	NO 0	COPY	Press [X] key to enter free format copy function.
[8] or [<<] and [>>]	S12.0	FREE	T8 8	COPY	Press [8] or [<<] and [>>] to select the existing label format you want to be copy.(Ex. T8)
[*]	S12.1	LABEL	56	WT MM	Change label width (Ex. No change).
[*]	S12.2	LABEL	55	HT MM	Change label height (Ex. No change).
[*]	S12.3	LABEL	0	DG ANGLE	Change print angle.(Ex. No change)
[*]	S12.4	LABEL	ITEM	LABEL	Select Item Label.
[*]	S12.5	PLU _{no}	1	F ITEM	Enter item setting.
[*][*][*][*]	S12.5	PLU _{no}	7	STATUS	Enter PLU Number print Status mode.
[C]or[0]	S12.5	PLU _{no}	0	STATUS	Change the status to NO PRINT
[*][*]	S12.5	PLU _{no}	1	F ITEM	Save the setting and go to next selection.
[8]	S12.5	COMM	8	F ITEM	Select Commodity Name program mode.
[*][*][3][2]	S12.5	COMM	23	Y MM	Enter Y position setting mode and change it from 23 mm to 32 mm and go to next selection.
[*]	S12.5	COMM	0	DG ANGLE	Change print angle.(Ex. No change)

OPERATION	DISPLAY				REMARK
	PT	kg	\$/kg	\$	
[*][*][1][5]	S12.5	COMM	15	HT MM	Enter TTL Height setting mode, change the height from 21 mm to 15 mm and go to next selection.
[*]	S12.5	COMM	7	STATUS	Enter print status. (Ex. No change)
[*]	S12.5	COMM	8	F ITEM	Save the Commodity Name print setting.
[2][0]	S12.5	INGR	20	F ITEM	Select Ingredient program mode.
[*]	S12.5	INGR	0	X MM	Enter Ingredient programmable mode.
[2][*]	S12.5	INGR	0	Y MM	Enter X Position value (Ex. 2mm) and go to next selection.
[2][3][*]	S12.5	INGR	0	DG ANGLE	Enter Y Position value (Ex. 23mm) and go to next selection.
[*]	S12.5	INGR	0	WT MM	Change print angle (Ex. No change).
[5][4][*]	S12.5	INGR	0	HT MM	Enter WIDTH value (Ex. 54mm) and go to next selection.
[1][0][*]	S12.5	INGR	0	STATUS	Enter HEIGHT value (Ex. 10mm) and go to next selection.
[7][*]	S12.5	INGR	20	F ITEM	Select print status (Ex. 7 = ALL PRINT) and go to next selection.
[PLU]	S12		FREE	FORMAT	Save the Free Format number 8.

3.17 Place File

PLACE file is used for programming a short text describing the place of production. The number of Characters possible to enter depends on the PLACE print area size and the character size used. Place will be printed in the free room of Commodity Name print area if selected label format without Place print area. Maximum 99 places (Place number 1 ~ 99) can be programmed, each with 1 line.

3.17.1 Program Place File

At Programming Mode, select Place programming mode and then enter new Place number (Ex. 1).

*For edit, enter existing Place number.

OPERATION	DISPLAY				REMARK
	PT	kg	\$ /kg	\$	
	S1		PLU	FILE	Enter S mode.
[1][5][*]	S15.0	PLACE	0	NO SET	Enter Place File programming mode.
[1][*]	S15.1	P01.01		S1 A100	Enter place file No.(Ex. No.1)
[M][A][D][E][S][P].....	S15.1	P01.13	DIGI	S1 A 88	Enter the Place File as the same procedures as Commodity Name Entry. (Ex. "MADE IN DIGI")
[SIZE][SIZE]...	S15.1	P01.13	DIGI	S5 A 48	Change font size to S5. (S1~S5; M1~M5; L1~L5)
[PLU]	S15		PLACE	FILE	Store Place File 1,back to S mode.

3.17.2 Delete Place File

At Place programming mode, enter existing Place Number (Ex. 1) to be deleted.

OPERATION	DISPLAY				REMARK
	PT	kg	\$ /kg	\$	
	S15.0	PLACE	0	NO SET	Enter Place File programming mode.
[1]	S15.0	PLACE	1	NO SET	Enter Place File number 1.
[-]	S15.0	FREE	DEL ?	Y-C N-T	Enter delete mode. [C] for Yes,[T] for No.
[C]	S15		PLACE	FILE	Delete Place File 1, back to S mode.

Note1: If you want to cancel the deletion, press [T] key to exit.

Note2: Non-existing Place File can not be deleted.

3.18 Machine Setting

OPERATION	DISPLAY				REMARK
	PT	kg	\$ /kg	\$	
	S1		PLU	FILE	Enter S mode.
[1][6][*]	S16.0	RATE	0.00	DISC	Program Machine Code.
[5][0][0]	S16.0	RATE	5.00	DISC	Enter default discount rate.(Ex. 5.00%)
[*]	S16		MACHIN	SETTING	Store machine setting, back to S mode.

Note: 0% to 99.99% are available for Default Discount Rate.

3.19 Logo File

Logo is the trademark of the shop, which will be printed in Label or Receipt. Logo will be printed on the top of receipt and on the left side of shop name on label. (When printing Logo data on Free Format Label, set the print area of Logo data on the Free Format in advance.)

Logo data can be programmed up to 4 logos. When using 4 logos for label, assign the LOGO KEY to preset key in advance. A logo data is formed by a pattern of dots (128 horizontal dots and 64 vertical dots.) However, since the Label logo data is printed within the limits, which are programmed in label formats, program the logo data within the limits of print area on the format.

Note: All standard formats have 37 dots x 30 dots for logo print area.

3.19.1 Pre-programming Logo Data

- 1) Prepare a section paper with 128 horizontal dots and 64 vertical dots.
- 2) When programming Label Logo, draw the limit of the Logo print area.
- 3) Draw the desired logo design in the section paper by filling the section with dot. (The dots are necessary to seize the image of the actual logo before programming.)

Example: DIGI Logo for label (37 x 30 dots)

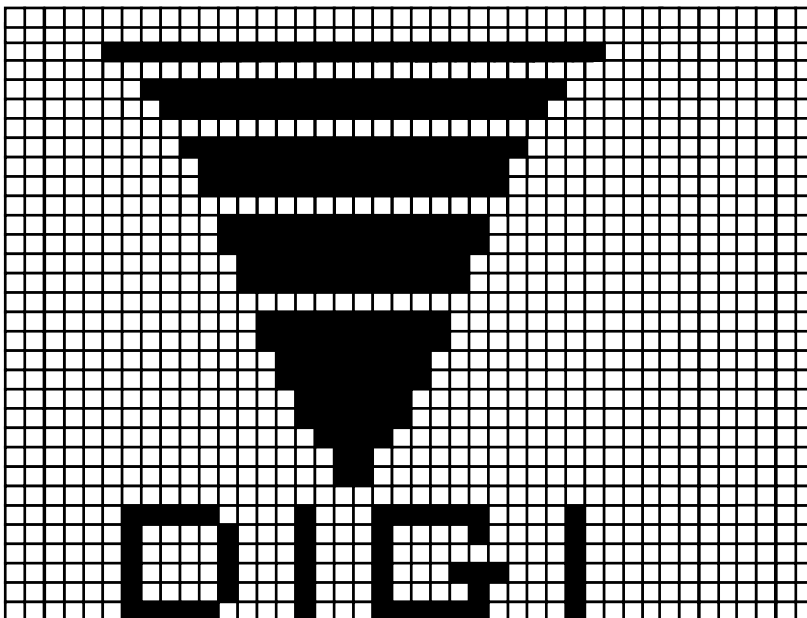

3.19.2 Program Display & Keys Function

Program Display for Logo Set Up

The following display appears when entering Logo Program Mode.

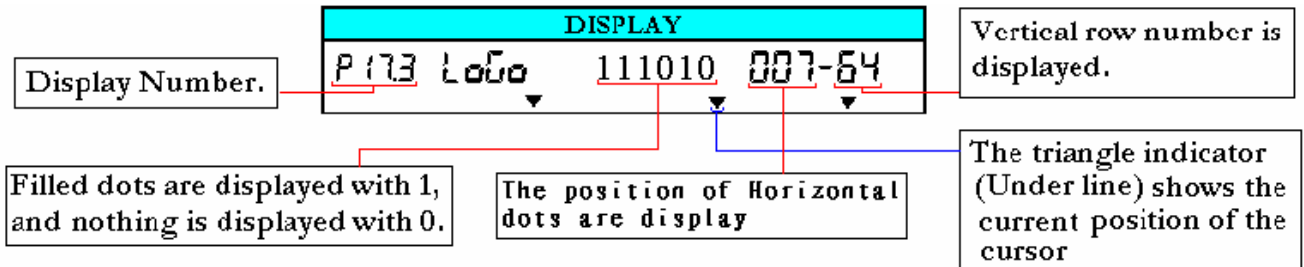

Key Function for LOGO Set Up

[0]	----- Clear a dot.
[1]	----- Fill a dot.
[<<]	----- Move the cursor to left. [←]
[>>]	----- Move the cursor to right. [→]
[⤴]	----- Move the cursor to up. [↑]
[⤵]	----- Move the cursor to down. [↓]
[*]	----- Move up to the first dot in the next line.
[PLU]	----- Store the Data.

3.19.3 Programming Order

- 1) After filling a section, programming status (the position of the cursor) moves to the next dot automatically.
- 2) When the programming status reached to the last dot (128 horizontal dots), or [*] key is depress, the programming status moves to the first left section on the next upper line automatically.

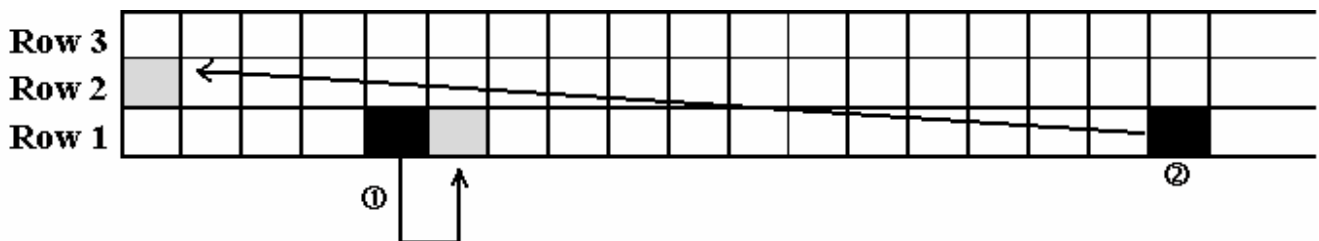

3.19.4 Program Logo File

At Programming Mode, select Logo programming mode and enter new Logo number. (Ex. 1)

*For edit, enter existing Logo number.

OPERATION	DISPLAY				REMARK
	PT	kg	\$/kg	\$	
	S1		PLU	FILE	Enter S mode.
[1][7][*]	S17.0	LOGO	0	NO SET	Enter Logo File programming mode. Enter Logo File number.(Ex. 1)
[1][*]	S17.1	LOGO	0	X-POS	Enter X position.(Ex. 7 dots)
[7][*]	S17.2	LOGO	0	Y-POS	Enter Y position.(Ex. 1dots)
[1][*]	S17.3	LOGO	000000	007-01	Set Fill or Clear dots you want and the save the setting and go to next upper line (Y 02).(Ex.11101110001)
[1][1].....[0][1][*]	S17.3	LOGO	000000	001-02	Press [>>] key to move the cursor to next dot.
Press [>>] key 6 times	S17.3	LOGO	000000	007-02	If necessary to change the position of the cursor been set, the following procedure is required.
[-][-]	S17.3	LOGO	7	X-POS	Change the Horizontal start position (Ex. 5 dots).
[5][*]	S17.3	LOGO	2	Y-POS	Change the Vertical start position (Ex. NO CHANGE).
[*]	S17.3	LOGO	000000	005-02	After complete program Logo data, save it.
[PLU]	S17		LOGO	FILE	Store the Logo 1 data, back to S mode.

Note! If you want to exit without saving, press [] key follow by [C] key.

3.19.5 Delete Logo File

At Logo programming mode, enter existing Logo Number (Ex. 1) to be deleted.

OPERATION	DISPLAY				REMARK
	PT	kg	\$ /kg	\$	
	S17.0	LOGO	0	NO SET	Enter Logo File programming mode.
[1]	S17.0	LOGO	1	NO SET	Enter Logo File number 1.
[-]	S17.0	LOGO	DEL ?	Y-C N-T	Enter delete mode. [C] for Yes,[T] for No.
[C]	S17		LOGO	FILE	Delete Logo File 1, back to S mode.

Note1: If you want to cancel the deletion, press [T] key to exit.

Note2: Non-existing Logo File can not be deleted.

3.20 Tax File

This function enables you to program consumption tax rate included or excluded in the price. Up to 10 Tax Numbers (1 - 10) can be programmed. The programmed Tax rates (Tax Number) that are linked to a Main Group will apply for all PLU's in that Main Group or set the Tax Number in individual PLU File. Tax Rates can be entered between 00.00 % - 99.99 %. To enable TAX programming mode, **SPEC 603** must set to **1 (TAX)** in advance.

There are two types of Taxes:

- **ADD ON TAX:** Tax is added to the Total Price.
- **VAT TAX:** Tax is included in the Total Price.

Note: If you want print **PRICE WITH TAX** on Item Label, the selected label format must has print area for Price + Tax and **SPEC 659: SELECTION OF ITEM PRICE PRINTING** must set to ITEM PRICE AFTER TAX in advance.

3.20.1 Program Tax File

At Programming Mode, select TAX programming mode and then enter new Tax number (Ex. 1) programming mode. *For edit, enter existing Tax number.

OPERATION	DISPLAY				REMARK
	PT	kg	\$ /kg	\$	
	S1		PLU	FILE	Enter S mode.
[1][8][*]	S18.0	TAX	0	NO SET	Enter Tax File programming mode. Enter Tax File number.(Ex. 1)
[1][*]	S18.1	TAX	0.00	INCLUDE	Enter default tax rate.(Ex. 3.00%)
[3][0][0]	S18.1	TAX	3.00	INCLUDE	Select tax type.
[<<] or [>>]	S18.1	TAX	3.00	EXCLUDE	Tax File 1 is value added tax.
[PLU]	S18		TAX	FILE	Store the Tax File 1 data, back to S mode.

Note1: 0 % to 99.99 % are available for Default Tax Rate.

Note2: [<<] and [>>] key can change the tax type. (Include / Exclude)

3.20.2 Delete Tax File

When the Tax Number linked to the existing Main Group File or PLU File, the Tax Number cannot be deleted. In addition, the Tax Number 1 cannot be deleted.

At Tax programming mode, enter existing Tax Number (Ex. 1) to be deleted.

OPERATION	DISPLAY				REMARK
	PT	kg	\$/kg	\$	
	S18.0	TAX	0	NO SET	Enter Tax File programming mode.
[1]	S18.0	TAX	1	NO SET	Enter Tax File number 1.
[-]	S18.0	TAX	DEL ?	Y-C N-T	Enter delete mode. [C] for Yes,[T] for No.
[C]	S18		TAX	FILE	Delete Tax File 1, back to S mode.

Note1: If you want to cancel the deletion, press [T] key to exit.

Note2: Non-existing Tax File can not be deleted.

3.21 Scroll Message File

Maximum 100 characters can be programmed for each scroll message and up to 9-scroll message data are available in scroll message file.

3.21.1 Program Scroll Message File

At Programming Mode, select Scrolling Message programming mode and then enter new Scroll Message number (Ex. 1) programming mode. *For edit, enter existing Scroll Message Number.

OPERATION	DISPLAY				REMARK
	PT	kg	\$ /kg	\$	
	S1		PLU	FILE	Enter S mode.
[1][3][*]	S13.0	SC MG	0	NO SET	Enter Scrolling Message programming mode. Enter Scrolling Message number.(Ex. 1)
[1][*]	S13.1	SC MG		0	
[W][E][L][C][O][M][E]][SP][T][O].....	S13.1	SC MG	STORE	21	Enter Scroll Message. (Ex. “WELCOME TO DIGI STORE”)
[PLU]	S13		SCROLL	MESSAGE	Store the Scroll message 1 data, back to S mode.

3.21.2 Delete Scroll Message File

When the Scroll message number is linked to Scroll Sequence, it can't be deleted.

At Scrolling Message program mode, enter existing Scroll Message Number (Ex. 1) to be deleted.

OPERATION	DISPLAY				REMARK
	PT	kg	\$ /kg	\$	
	S13.0	SC MG	0	NO SET	Enter Scrolling Message programming mode.
[1]	S13.0	SC MG	1	NO SET	Enter Scrolling Message number.(Ex. 1)
[-]	S13.0	SC MG	DEL ?	Y-C N-T	Enter delete mode. [C] for Yes,[T] for No.
[C]	S13		SCROLL	MESSAGE	Delete Scrolling Message File 1, back to S mode.

Note1: If you want to cancel the deletion, press [T] key to exit.

Note2: Non-existing Scroll Message File can not be deleted.

3.22 Scroll Sequence File

Scroll Sequence # 1 to # 3 is available. Each scroll sequence consists of up to three kinds of Messages. Scroll Sequence means the scroll display order and display appearance of the programmed scroll message.

3.22.1 Program Scroll Sequence File

At Programming Mode, select Scrolling Sequence programming mode and then enter new Scroll Sequence number (Ex. 1) programming mode. *For edit, enter existing Scroll Sequence Number.

OPERATION	DISPLAY				REMARK
	PT	kg	\$ /kg	\$	
	S1		PLU	FILE	Enter S mode.
[1][4][*]	S14.0	SC SQ	0	NO SET	Enter Scrolling Sequence programming mode.
[1][*]	S14.1	SC SQ	MSG NO	000	Enter Scrolling Sequence file number.(Ex. 1)
[1][2][3][*]	S14.2	SC SQ	ATTRIB	123 000	Enter existing Scrolling Message Number.(Ex. 1, 2, 3)
[1][2][3][*]	S14.2	SC SQ	SPEED	123 000	Select Scrolling pattern for each Scrolling Message. (Ex. MSG#1=1, MSG#2=2 & MSG#3=3)
[1][2][0]	S14.2	SC SQ	SPEED	123 120	Select Scrolling Rate. (Ex. MSG#1=1:NORMAL,MSG#2 =2:FAST and MSG#3=0:SLOW)
[PLU]	S14		SCROLL	SEQUENC	Store the Scroll message 1 data, back to S mode.

The scrolling pattern is as following.

0: L-SCROLL: Maximum100 characters

1: BLINKING: Maximum 25 characters

2: STATIS: Maximum 25 characters

3: R -SCROLL: Maximum100 characters

4: WIPE IN: Maximum 25 characters

3.22.2 Enable or Disable Scroll Sequence File

This Function is used to enable the programmed Scroll Message data by Scroll Sequence Number shows on the Display in Registration Mode when scale in idle time. The Scroll Message, Scrolling Pattern and Speed will follow Scroll Sequence Number setting.

Enable Scroll Sequence File

At Scroll Sequence programming Mode, enter Scroll Sequence Number you want (Ex. 1).

OPERATION	DISPLAY				REMARK
	PT	kg	\$/kg	\$	
	S14.0	SC SQ	0	NO SET	Enter Scrolling Sequence programming mode.
[1]	S14.0	SC SQ	1	NO SET	Enter Scrolling Sequence file number.(Ex. 1)
[PLU]	S14		SCROLL	SEQUENC	Enable Scrolling Sequence Number 1, back to S mode.

Note! If you want to change the Scroll Sequence number, enter new sequence number follow by press [PLU] key.

Disable Scrolling Message

At Scroll Sequence programming Mode, enter Scroll Sequence Number you want (Ex. 0).

OPERATION	DISPLAY				REMARK
	PT	kg	\$/kg	\$	
	S14.0	SC SQ	0	NO SET	Enter Scrolling Sequence programming mode.
[0]	S14.1	SC SQ	0	NO SET	Enter Scrolling Sequence file number.(Ex. 0)
[PLU]	S14		SCROLL	SEQUENC	disable Scrolling Sequence Number 1, back to S mode.

3.22.3 Delete Scroll Sequence Number

When the Scroll Sequence Number to be deleted is in Used, it can't be deleted.

At Scroll Sequence programming mode, enter existing Scroll Sequence Number (Ex. 1) to be deleted.

OPERATION	DISPLAY				REMARK
	PT	kg	\$/kg	\$	
	S14.0	SC SQ	0	NO SET	Enter Scrolling Sequence programming mode.
[1]	S14.0	SC SQ	1	NO SET	Enter Scrolling Sequence file number.(Ex. 1)
[-]	S14.0	SC SQ	DEL ?	Y-C N-T	Enter delete mode. [C] for Yes,[T] for No.
[C]	S14		SCROLL	SEQUENC	Delete Scrolling Sequence Number 1, back to S mode.

Note1: If you want to cancel the deletion, press [T] key to exit.

Note2: Non-existing Scroll Sequence File can not be deleted.

3.23 ASCII Character Input Method

Insert Key-sheet for ASCII Character Input: (For standard version)

<u>A/a</u> 1	<u>B/b</u> 2	<u>C/c</u> 3	<u>D/d</u> 4	<u>E/e</u> 5	<u>F/f</u> 6	<u>G/g</u> 7	<u>H/h</u> 8	<u>I/i</u> 9	CODE
<u>J/j</u> 0	<u>K/k</u> !	<u>L/l</u> @	<u>M/m</u> #	<u>N/n</u> \$	<u>O/o</u> %	<u>P/p</u> ^	<u>Q/q</u> &	<u>R/r</u> *	SIZE
<u>S/s</u> (<u>T/t</u>)	<u>U/u</u> :	<u>V/v</u> =	<u>W/w</u> "	<u>X/x</u> /	<u>Y/y</u> -	<u>Z/z</u> \	SP	DEL
<u>?/?</u> +	<u>ü/ü</u> ?	<u>?/?</u> <	<u>é/é</u> .	<u>?/?</u> >	<u>?/?</u> ,	<u>à/á</u> €	<u>?/í</u> ó		

Each key includes 3-4 ASCII character.

Example: Key [A/a/1/!] includes ASCII character: A, a and 1.

Operation	ASCII	Display	Indicate	Remarks
Depress the key one time	INPUT 'A'	A	Lamp P turns on	*note 1
Depress the key two times	INPUT 'a'	a	Lamp P turns off	*note2
Depress the key three times	INPUT '1'	1	Lamp P turns off	*note3

Note1: Lamp P turning on indicates capital letter is use in PLU programming.

Note2: After one letter input, the indicator under the letter is flicker 1.5 seconds.

Note3: When the indicator under the letter is flicker, depress the same key can change the input to the next ASCII character.

3.24 ASCII Code Input Method

ASCII Code Input Method is another kind of input method for ASCII character entry. [CODE] Key can switch the input method between ASCII Code Input Method and ASCII Character Key In Method.

Example: Use the ASCII Code Input Method to entry commodity name. (CAKE)

OPERATION	DISPLAY				REMARK
	PT	kg	\$ /kg	\$	
.....
	S1.3	C01.01		S1 A 22	Enter commodity name.
[CODE]	S1.3	C01.01	A-	S1 A 22	Press [CODE] to switch to ASCII Code Input .
[6][7]	S1.3	C01.02	A-	S1 A 21	ASCII Code 67 figures Character 'C'.
[6][5]	S1.3	C01.03	A-	S1 A 20	ASCII Code 65 figures Character 'A'.
[7][5]	S1.3	C01.04	A-	S1 A 19	ASCII Code 75 figures Character 'K'.
[6][9]	S1.3	C01.05	A-	S1 A 18	ASCII Code 69 figures Character 'E'.
[CODE]	S1.3	C01.01	CAKE	S1 A 18	Switch to key in method. The inputted characters will be displayed in the Unit Price window.
.....

Note1: Decimal digital from 32 to 255 can be entered. Each Decimal digital figures one ASCII Character.

Note2: Different Countries can refer to the local ASCII Code List.

4. REGISTRATION MODE

4.1 ON/OFF

1 - ZERO 2 - NET 3 - FIX T 4 - FIX P

OPERATION	KEYS	PT kg	Kg	\$/kg	\$	1	2	3	4
Power on.	[ON/OFF]	0 0 0 0	0 0 0 0 0	0 0 0 0 0 0	0 0 0 0 0 0 0				
		1 1 1 1	1 1 1 1 1	1 1 1 1 1 1	1 1 1 1 1 1 1				
		2 2 2 2	2 2 2 2 2	2 2 2 2 2 2	2 2 2 2 2 2 2				
		1 3 3 3	3 3 3 3 3	3 3 3 3 3 3	3 3 3 3 3 3 3				
		4 4 4 4	4 4 4 4 4	4 4 4 4 4 4	4 4 4 4 4 4 4				
		5 5 5 5	5 5 5 5 5	5 5 5 5 5 5	5 5 5 5 5 5 5				
		6 6 6 6	6 6 6 6 6	6 6 6 6 6 6	6 6 6 6 6 6 6				
		7 7 7 7	7 7 7 7 7	7 7 7 7 7 7	7 7 7 7 7 7 7				
		8 8 8 8	8 8 8 8 8	8 8 8 8 8 8	8 8 8 8 8 8 8				
		9 9 9 9	9 9 9 9 9	9 9 9 9 9 9	9 9 9 9 9 9 9				
		****	*****	*****	*****				
					
		, , , ,	, , , , ,	, , , , , ,	, , , , , , ,				
		^^ ^^	^^ ^^ ^^	^^ ^^ ^^ ^^	^^ ^^ ^^ ^^ ^^				
		8 8 8 8	8 8 8 8 8	8 8 8 8 8 8	8 8 8 8 8 8 8				
Stand-by-status.		0.0 0 0	0.0 0 0	0.0 0	0.0 0	▼			
Power off.	[ON/OFF]								

4.2 Reset and Weighing Check

All weighing operations will be performed based on the procedure shown below. Operator should check this operation before any transactions.

1 - ZERO 2 - NET 3 - FIX T 4 - FIX P

OPERATION	KEYS	PT kg	Kg	\$/kg	\$	1	2	3	4
Stand-by-status.		0.0 0 0	0.0 0	0.0 0	0.0 0	▼			
Reset the zero point.	[REZERO]	8 8 8 8	8 8 8 8 8	8 8 8 8 8 8	8 8 8 8 8 8 8				
		0.0 0 0	0.0 0	0.0 0	0.0 0	▼			
Place an item on the platter. (e.g. 1.00kg)		0.0 0 0	1.0 0 0	0.0 0	0.0 0				
	[1] [2] [0]	0.0 1 0	1.0 0 0	1.2 0	1.2 0				
Remove the item from platter.		0.0 0 0	0.0 0 0	0.0 0	0.0 0	▼			

4.3 Tare Subtraction

4.3.1 One touch Tare Subtraction

OPERATION	KEYS	1 - ZERO 2 - NET 3 - FIX T 4 - FIX P				1	2	3	4
		PT kg	Kg	\$/kg	\$				
Stand-by-status.		0.0 0 0	0.0 0 0	0.0 0	0.0 0	▼			
Put tare (e.g 30 g) on platter.		0.0 0 0	0.0 3 0	0.0 0	0.0 0				
Subtract the tare weight.	[T]	0.0 3 0	0.0 0 0	0.0 0	0.0 0		▼		
Remove the tare weight		0.0 3 0	-0.0 3 0	0.0 0	0.0 0	▼	▼		
Clear the tare weight.	[T]	0.0 0 0	0.0 0 0	0.0 0	0.0 0	▼			

4.3.2 Digital tare Subtraction

OPERATION	KEYS	1 - ZERO 2 - NET 3 - FIX T 4 - FIX P				1	2	3	4
		PT kg	Kg	\$/kg	\$				
Stand-by-status.		0.0 0 0	0.0 0 0	0.0 0	0.0 0	▼			
Key in the tare weight (e.g 5g).	[5]	0.0 0 0	0.0 0 0	0.0 5	0.0 0	▼			
Subtract the tare weight (Assume 15kg).	[T]	0.0 0 5	-0.0 0 5	0.0 0	0.0 0	▼	▼		
Clear the tare weight.	[T]	0.0 0 0	0.0 0 0	0.0 0	0.0 0	▼			

4.4 PLU Call Up

There are three ways to call up programmed PLU:

- Manual PLU Call Up
- By press assigns to the preset key that desired PLU.
- Auto PLU Call Up.

Note: The machine beeps if incorrect operation is performed when during PLU calls up.

- call Non-Weighed PLU up when something is on the platter.
- Non-PLU with the entered number exists.
- PLU Preset Key not set.

4.4.1 Manual PLU Call Up

Manual PLU Call up is by enter the PLU Number by numeric Keys and then follow by pressing **[PLU]** key on Keypad.

OPERATION	KEYS	PT kg	Kg	\$ /kg	\$	1 - ZERO 2 - NET 3 - FIX T 4 - FIX P			
						1	2	3	4
Stand-by-status		0.0 0 0	0.0 0 0	0.0 0	0.0 0	▼			
Enter the PLU No. of the Beef steak.(Ex.No.10)	[0] [1] [0]	0.0 0 0	0.0 0 0	1.00	0.0 0	▼			
Press PLU key.	[PLU]	0.0 0 0	0.0 0 0	1.2 0	0.0 0	▼			
Clear the PLU and return to Stand-by-status.	[C]	0.0 0 0	0.0 0 0	0.0 0	0.0 0	▼			

4.4.2 PLU Call Up by Preset Key

To enable this function, the PLU must assign on the Preset Key in advance.

OPERATION	KEYS	PT kg	Kg	\$ /kg	\$	1 - ZERO 2 - NET 3 - FIX T 4 - FIX P			
						1	2	3	4
Stand-by-status		0.0 0 0	0.0 0 0	0.0 0	0.0 0	▼			
Press the Preset key where desired PLU is assigned.	[P1]	0.0 0 0	0.0 0 0	1.2 0	0.0 0	▼			
Clear the PLU and return to Stand-by-status.	[C]	0.0 0 0	0.0 0 0	0.0 0	0.0 0	▼			

4.4.3 PLU Call by Numeric Key (Auto PLU Call)

There are two type of Auto PLU Call, by enter the Specification Digits of the PLU Number or by TIME-OUT is depending on Spec Setting.(Spec39 and Spec40)

OPERATION	KEYS	PT kg	Kg	\$ /kg	\$	1 - ZERO 2 - NET 3 - FIX T 4 - FIX P			
						1	2	3	4
Stand-by-status		0.0 0 0	0.0 0 0	0.0 0	0.0 0	▼			
Enter the PLU No. of the Beef steak	[0] [1] [0]	0.0 0 0	0.0 0 0	0.1 0	0.0 0	▼			
		0.0 0 0	0.0 0 0	1.20	0.00				
Clear the PLU and return to Stand-by-status.	[C]	0.0 0 0	0.0 0 0	0.0 0	0.0 0	▼			

4.5 Fix Operation

4.5.1 Fix Tare by FIX Key

OPERATION	KEYS	PT kg	Kg	\$ /kg	\$	1 - ZERO 2 - NET 3 - FIX T 4 - FIX P			
						1	2	3	4
Stand-by-status.		0.0 0 0	0.0 0 0	0.0 0	0.0 0	▼			
Put tare (e.g 30 g) on platter.		0.0 0 0	0.0 3 0	0.0 0	0.0 0				
Subtract the tare weight.	[T]	0.0 3 0	0.0 0 0	0.0 0	0.0 0		▼		
Fix tare.	[FIX]	0.0 3 0	0.0 0 0	0.0 0	0.0 0		▼	▼	
Cancel fix tare by FIX key.	[FIX]	0.0 3 0	0.0 0 0	0.0 0	0.0 0		▼		
Add tare (e.g 10 g) on platter.		0.0 3 0	0.0 1 0	0.0 0	0.0 0				
Subtract the tare weight.	[T]	0.0 4 0	0.0 0 0	0.0 0	0.0 0		▼		
Fix tare.	[FIX]	0.0 4 0	0.0 0 0	0.0 0	0.0 0		▼	▼	
Remove the tare weight.		0.0 4 0	-0.0 4 0	0.0 0	0.0 0	▼	▼	▼	
Key in the tare weight (e.g 50g).	[5] [0]	0.0 4 0	-0.0 4 0	0.5 0	0.0 0	▼	▼	▼	
Set new tare and cancel fix tare by T key.	[T]	0.0 5 0	-0.0 5 0	0.0 0	0.0 0	▼	▼		
Fix tare.	[FIX]	0.0 5 0	-0.0 5 0	0.0 0	0.0 0	▼	▼	▼	
Clear the tare weight and fix tare.	[T]	0.0 0 0	0.0 0 0	0.0 0	0.0 0	▼			

4.5.2 Fix PLU by FIX Key

OPERATION	KEYS	PT kg	Kg	\$ /kg	\$	1 - ZERO 2 - NET 3 - FIX T 4 - FIX P			
						1	2	3	4
Stand-by-status.		0.0 0 0	0.0 0 0	0.0 0	0.0 0	▼			
Enter the PLU No. of the Beef steak	[1] [0]	0.0 0 0	0.0 0 0	0.1 0	0.0 0	▼			
Press PLU key.	[PLU]	0.0 0 0	0.0 0 0	1.2 0	0.0 0	▼			
Fix PLU.	[FIX]	0.0 0 0	0.0 0 0	1.2 0	0.0 0	▼			▼
Cancel fix PLU by FIX key.	[FIX]	0.0 0 0	0.0 0 0	1.2 0	0.0 0	▼			
Enter the PLU No. of the Beef steak	[1] [0]	0.0 0 0	0.0 0 0	0.1 0	0.0 0	▼			
Press PLU key.	[PLU]	0.0 0 0	0.0 0 0	1.2 0	0.0 0	▼			
Fix PLU.	[FIX]	0.0 0 0	0.0 0 0	1.2 0	0.0 0	▼			▼
Enter the PLU No. of the Roast Beef.	[2] [0]	0.0 0 0	0.0 0 0	0.2 0	0.0 0	▼			▼
Call up PLU and cancel fix P.	[PLU]	0.0 0 0	0.0 0 0	2.4 0	0.0 0	▼			
Fix PLU	[FIX]	0.0 0 0	0.0 0 0	2.4 0	0.0 0	▼			▼
Clear PLU and fix PLU.	[C]	0.0 0 0	0.0 0 0	0.0 0	0.0 0	▼			

4.5.3 Fix Unit Price by FIX Key

OPERATION	KEYS	PT kg	Kg	\$ /kg	\$	1 - ZERO 2 - NET 3 - FIX T 4 - FIX P			
						1	2	3	4
Stand-by-status.		0.0 0 0	0.0 0 0	0.0 0	0.0 0	▼			
Enter unit price.	[1] [0] [0]	0.0 0 0	0.0 0 0	1.0 0	0.0 0	▼			
Fix unit price.	[FIX]	0.0 0 0	0.0 0 0	1.0 0	0.0 0	▼			▼
Cancel fix unit price.	[FIX]	0.0 0 0	0.0 0 0	1.0 0	0.0 0	▼			
Enter unit price.	[2] [0] [0]	0.0 0 0	0.0 0 0	2.0 0	0.0 0	▼			
Fix unit price.	[FIX]	0.0 0 0	0.0 0 0	2.0 0	0.0 0	▼			▼
Clear unit price and fix unit price.	[C]	0.0 0 0	0.0 0 0	0.0 0	0.0 0	▼			

4.6 Operation Mode Change

1 - ZERO 2 - NET 3 - PREPACK 4 - MANUAL 5 - LABEL

OPERATION	KEYS	PT kg	Kg	S/kg	\$	1	2	3	4	5
Receipt mode.		0.0 0 0	0.0 0 0	0.0 0	0.0 0	▼				
Depress [MODE] key while depressing [REZERO] key.	[REZERO] [REZERO]+[MODE]	8 8 8 8	8 8 8 8 8	8 8 8 8 8 8	8 8 8 8 8 8 8					
Set to label manual mode.		0.0 0 0	0.0 0 0	0.0 0	0.0 0	▼			▼	▼
Depress [MODE] key while depressing [REZERO] key.	[REZERO] [REZERO]+[MODE]	8 8 8 8	8 8 8 8 8	8 8 8 8 8 8	8 8 8 8 8 8 8					
		0.0 0 0	0.0 0 0	0.0 0	0.0 0	▼				
Set to receipt mode.		0.0 0 0	0.0 0 0	0.0 0	0.0 0	▼				

4.7 Item Label Printing in Manual Mode

You can use this operation to print out item labels for a PLU or Non-PLU of Weighing Item or Non-weighing Item. Before the operation, check the following point.

- ◆ Press [REZERO] and [MODE] to select LABEL mode.
- ◆ Check whether the Label Size fits the programmed one in PLUs when label is used.

4.7.1 Label Printing for PLU Item

For example: Sell 1kg of BEEF STEAK(Ex. PLU #: 10) (Weighing Item).

1 - ZERO 2 - NET 3 - FIX T 4 - FIX P 5 - MANUAL 6 - LABEL

OPERATION	KEYS	PT kg	Kg	\$/kg	\$	1	2	3	4	5	6
Stand-by-status.		0.0 0 0	0.0 0 0	0.0 0	0.0 0	▼				▼	▼
Enter the PLU No. of the Beef steak.	[1] [0]	0.0 0 0	0.0 0 0	0.1 0	0.0 0	▼				▼	▼
Press PLU key.	[PLU]	0.0 0 0	0.0 0 0	1.2 0	0.0 0	▼				▼	▼
Place the product on the platter. (e.g. 1kg)		0.0 0 0	1.0 0 0	1.2 0	1.2 0					▼	▼
Print out one item label.	[*]	0.0 0 0	1.0 0 0	1.2 0	1.2 0	▼				▼	▼
Remove the product from the platter.	[C]	0.0 0 0	0.0 0 0	0.0 0	0.0 0	▼				▼	▼

For example: Sell one pack of SMOKED SAUSAGE (Ex. PLU #: 30) and sell five packs of SLICED BACON (Ex. PLU #: 40). (Non-weighing Item)

1 - ZERO 2 - NET 3 - FIX T 4 - FIX P 5 - MANUAL 6 - LABEL

OPERATION	KEYS	PT kg	Kg	\$/kg	\$	1	2	3	4	5	6
Stand-by-status.		0.0 0 0	0.0 0 0	0.0 0	0.0 0	▼				▼	▼
Enter the PLU No. of the Smoked Sausage.	[3] [0]	0.0 0 0	0.0 0 0	0.3 0	0.0 0	▼				▼	▼
Press PLU key.	[PLU]			2.5 0	PR-PCS					▼	▼
Press [*] key to print label.	[*]	0.0 0 0	0.0 0 0	0.0 0	1.2 0	▼				▼	▼
Enter the PLU No. of the Sliced Bacon.	[4] [0]	0.0 0 0	0.0 0 0	0.4 0	0.0 0	▼				▼	▼
Press PLU key.	[PLU]			3.2 0	PR-PCS					▼	▼
Multiply.	[X]		QTY 1	3.2 0	3.2 0					▼	▼
5 packs.	[5]		QTY 5	3.2 0	1 6.0 0					▼	▼
Print out one item label.	[*]	0.0 0 0	0.0 0 0	0.0 0	0.0 0	▼				▼	▼

4.7.2 Label Printing for NON-PLU Item

It is possible to print item label for Non-PLU Item at Manual Mode. The Non-PLU Item will be cleared is a PLU is called up or **[C]** key is pressed.

Note: For Weighing of Non-PLU Item will be registered to PLU # 999998.

For Non-weight of Non-PLU item, will be registered to PLU # 999999.

For example: Enter the Price for Non-PLU item (Ex. 5.00) by numeric key.

Note: For Non-weight Item, just press **[*]** key to issue out a label or press **[X]** key to enter multiply mode, then enter sale quantity and press **[*]** key to issue label.

1 - ZERO 2 - NET 3 - FIX T 4 - FIX P 5 - MANUAL 6 - LABEL

OPERATION	KEYS	PT kg	Kg	\$/kg	\$	1	2	3	4	5	6
Stand-by-status.		0.0 0 0	0.0 0 0	0.0 0	0.0 0	▼				▼	▼
Enter the unit price	[5] [0] [0]	0.0 0 0	0.0 0 0	5.0 0	0.0 0	▼				▼	▼
Multiply.	[X]		QTY 1	5.00	5.00					▼	▼
5 packs.	[5]		QTY 5	5.0 0	25.0 0					▼	▼
Print out one item label.	[*]	0.0 0 0	0.0 0 0	0.0 0	0.0 0	▼				▼	▼

4.8 Total Label Printing in Manual Mode

This operation is used for printing total label in Manual Mode.

4.8.1 Sales Transaction

This section shows how to operate the transactions with Clerk key. The designated Clerk key accumulates each transaction data and **Total Label** will be issued.

For example: Sells 1.5 kg of HERB CHEESE(Ex. PLU #: 3) and 2 packs of SKIM MILK(Ex. PLU # 302) for customer A.

1 - ZERO 2 - NET 3 - V1 4 - V2 5 - V3 6 - V4

OPERATION	KEYS	PT kg	Kg	S/kg	\$	1	2	3	4	5	6
Stand-by-status.		0.0 0 0	0.0 0 0	0.0 0	0.0 0	▼					
Enter the PLU No. of the HERB CHEESE	[3][PLU]	0.0 0 0	0.0 0 0	5.0 0	0.0 0	▼					
Place the product on the platter. (1.5kg)		0.0 0 0	1.5 0 0	5.0 0	7.5 0						
Register sales item to Vender1.	[V1]	-V1-	TOTAL	1PCS	7.5 0			▼			
	[C]	0.0 0 0	0.0 0 0	0.0 0	0.0 0	▼		▼			
Enter the PLU No. of the SKIM MILK	[3][0][2][PLU]			3.0 0	PR-PCS			▼			
Enter the sell Qty (Ex. 2 packs)	[X][2]		QTY 2	3.0 0	6.0 0			▼			
Register sales item to Vender1.	[V1]	-V1-	TOTAL	3PCS	13.5 0			▼			
Print out one total label.	[*]	0.0 0 0	0.0 0 0	0.0 0	0.0 0	▼					

4.8.2 [PRICE DISCOUNT] Function Key in Add Mode

This function key is used to get the desirable discounted total price in Add. Mode by subtracting the discount value from the original total price when issuing total label or receipt. The formula is shown as follows

$$\text{PRICE TO PAY} = \text{ORIGINAL TOTAL PRICE} - \text{ENTERED DISCOUNT VALUE}$$

Note: Prior to this operation, [PRICE DISCOUNT] Function should be assigned to Preset Key in advance (Ex. Assign to Preset Key No.2).

		1 - ZERO		2 - NET		3 - V1		4 - V2		5 - V3		6 - V4	
OPERATION	KEYS	PT kg	Kg	\$/kg	\$	1	2	3	4	5	6		
Stand-by-status.		0.0 0 0	0.0 0 0	0.0 0	0.0 0	▼							
Enter the PLU No. of the Beef steak.	[1] [0]	0.0 0 0	0.0 0 0	0.1 0	0.0 0	▼							
Press PLU key.	[PLU]	0.0 0 0	0.0 0 0	1.20	0.0 0								
Place the product on the platter. (e.g. 1kg)		0.0 0 0	1.0 0 0	1.20	1.2 0								
Register sales item to Vender1.	[V1]	-V1-	TOTAL	1PCS	1.2 0			▼					
Press [P2] key.	[P2]	-V1-	DISC		0.00			▼					
Enter discount value. (Ex. \$ 0.20)	[2] [0]	-V1-	DISC		0.20			▼					
Confirm.	[*]	-V1-	TOTAL	1PCS	1.00			▼					
	[C]	0.0 0 0	0.0 0 0	0.0 0	0.0 0	▼		▼					

4.8.3 [PRICE % DISCOUNT] Function Key in Add Mode

This function key is used to get the desirable discounted total price in Add Mode by setting the discount % value from the original total price when issuing total label or receipt. The formula is shown as follows

$$\text{PRICE TO PAY} = \text{ORIGINAL TOTAL PRICE} \times (100\% - \text{DISCOUNT \% VALUE})$$

Note: Prior to this operation, [PRICE % DISCOUNT] Function should be assigned to Preset Key in advance (Ex. Assign to Preset Key No.3).

		1 - ZERO		2 - NET		3 - V1		4 - V2		5 - V3		6 - V4	
OPERATION	KEYS	PT kg	Kg	\$/kg	\$	1	2	3	4	5	6		
Stand-by-status.		0.0 0 0	0.0 0 0	0.0 0	0.0 0	▼							
Enter the PLU No. of the Beef steak.	[1] [0]	0.0 0 0	0.0 0 0	0.1 0	0.0 0	▼							
Press PLU key.	[PLU]	0.0 0 0	0.0 0 0	1.20	0.0 0								
Place the product on the platter. (e.g. 1kg)		0.0 0 0	1.0 0 0	1.20	1.2 0								
Register sales item to Vender1.	[V1]	-V1-	TOTAL	1PCS	1.2 0			▼					
Press [P3] key.	[P1]	-V1-	DISC	RATE	0.00			▼					
Enter discount rate. (Ex.10%)	[1] [0] [0] [0]	-V1-	DISC	RATE	10.00			▼					
Confirm.	[*]	-V1-	TOTAL	1PCS	1.08			▼					
	[C]	0.0 0 0	0.0 0 0	0.0 0	0.0 0	▼		▼					

4.9 Data Correction

The data correction during accumulating operation is to correct sales transaction data when customer canceled the purchases or operators make a mistake before issuing Total Label or Receipt. The corrected item data is printed with two lines crossed on the Total Receipt.

SM-100 has 2 correcting functions as follows:

1) **On-the-spot Correction**

Is to void the last item data during accumulating operation.

2) **Void by Item Correction**

Is to void sales data by tracing transaction number during accumulating operation.

4.9.1 On The Spot Correction

This function is to void the last item data of an accumulating operation, when an operator noticed it was a mistake or a customer canceled purchase before issuing a Receipt or Total Label. It is effective for either weighed or non-weighted item in the last transaction.

Transaction Example Vender 1: (1) 1kg of BEEF STEAK.

(2) One pack of Smoked Sausage.

(3) More 5kg of BEEF STEAK.

But customer canceled 5kg of BEEF STEAK accumulated in the last operation.

1 - ZERO 2 - NET 3 - V1 4 - V2 5 - V3 6 - V4

OPERATION	KEYS	PT kg	Kg	\$/kg	\$	1	2	3	4	5	6
Stand-by-status.		0.0 0 0	0.0 0 0	0.0 0	0.0 0	▼					
Enter the PLU No. of the Beef Sirloin.	[1] [0] [PLU]	0.0 0 0	0.0 0 0	1.2 0	0.0 0	▼					
Place the product on the platter. (e.g. 1kg)		0.0 0 0	1.0 0 0	1.2 0	1.2 0						
Register sales item to Vender1	[V1]	-V1-	TOTAL	1PCS	1.2 0			▼			
Remove the product from the platter.		0.0 0 0	0.0 0 0	0.0 0	0.0 0	▼		▼			
Enter the PLU No. of the Smoked Sausage.	[3] [0] [PLU]			2.5 0	PR-PCS			▼			
Register sales item to Vender1	[V1]	-V1-	TOTAL	2PCS	3.7 0			▼			
Enter the PLU No. of the Beef Sirloin.	[1] [0] [PLU]	0.0 0 0	0.0 0 0	1.2 0	0.0 0	▼		▼			
Place the product on the platter. (e.g. 5kg)		0.0 0 0	5.0 0 0	1.2 0	6.0 0			▼			
Register sales item to Vender1	[V1]	-V1-	TOTAL	3PCS	9.7 0			▼			
Delete the last item entry.	[-]	-V1-	TOTAL	2PCS	3.7 0			▼			
	[C]	0.0 0 0	0.0 0 0	0.0 0	0.0 0	▼		▼			

4.9.2 Void by Item Correction

This function is to void the **specified transaction** during an accumulating operation. Operator can designate the number of transaction to be voided even if plural transactions for the same item are performed.

- Transaction example** Vender 1:
- (1) 1kg of BEEF STEAK.
 - (2) One pack of Smoked Sausage.
 - (3) More 5kg of BEEF STEAK.

But customer canceled One pack of Smoked Sausage in the 2nd transaction.

1 - ZERO 2 - NET 3 - V1 4 - V2 5 - V3 6 - V4

OPERATION	KEYS	PT	kg	Kg	S/kg	S	1	2	3	4	5	6
Stand-by-status.		0.0	0.0	0.0	0.0	0.0	▼					
Enter the PLU No. of the Beef Sirloin.	[1] [0] [PLU]	0.0	0.0	0.0	1.2	0.0	▼					
Place the product on the platter. (e.g. 1kg)		0.0	0.0	1.0	1.2	1.2						
Register sales item to Vender1	[V1]	-V1-	TOTAL	1PCS	1.2				▼			
Remove the product from the platter.	[C]	0.0	0.0	0.0	0.0	0.0	▼		▼			
Enter the PLU No. of the Smoked Sausage.	[3] [0] [PLU]				2.5	PR-PCS			▼			
Register sales item to Vender1	[V1]	-V1-	TOTAL	2PCS	3.7				▼			
Enter the PLU No. of the Beef Sirloin.	[1] [0] [PLU]	0.0	0.0	0.0	1.2	0.0	▼		▼			
Place the product on the platter. (e.g. 5kg)		0.0	0.0	5.0	1.2	6.0			▼			
Register sales item to Vender1	[V1]	-V1-	TOTAL	3PCS	9.7				▼			
	[C]	0.0	0.0	0.0	0.0	0.0	▼		▼			
Delete the selected item.	[-]			VD 1	1PCS	1.2			▼			
[<<] or [>>] to search the item.	[>>]			VD 2	1PCS	2.5			▼			
Delete the selected item.	[*]	0.0	0.0	0.0	0.0	0.0	▼		▼			
Check Vender1 sale total.	[V1]	-V1-	TOTAL	2PCS	7.2				▼			
	[C]	0.0	0.0	0.0	0.0	0.0	▼		▼			

4.10 Item Label Printing in Pre-pack Mode

Pre-pack Mode can be switched from Manual mode by pressing **[AUTO]** key. In this mode, the following functions are available,

- (1) For weighing item, label is automatically issued (without pressing **[*]** key) after the weight of the item gets stable. The machine keeps the PLU data until **[C]** key is pressed.
- (2) For non-weighing item, the next label is automatically issued (without pressing **[*]** key) after a label is taken away. The machine keeps the PLU data until **[C]** key is pressed.

4.10.1 Item Label Issue for PLU Item

For example: To weighing (Ex. 1kg) 20 packs of FRIED POTATOES (Weighing Item, PLU #8)

1 - ZERO 2 - NET 3 - FIX T 4 - FIX P 5 - PREPACK 6 - LABEL

OPERATION	KEYS	PT kg	Kg	\$/kg	\$	1	2	3	4	5	6
Stand-by-status.		0.0 0 0	0.0 0 0	0.0 0	0.0 0	▼					▼
Press [AUTO] key	[AUTO]	0.0 0 0	0.0 0 0	0.0 0	0.0 0	▼				▼	▼
Enter the PLU No. of the FRIED POTATOES (Ex. PLU#8).	[8][PLU]	0.0 0 0	0.0 0 0	2.2 3	0.0 0	▼				▼	▼
Place the product on the platter. (e.g. 1kg) (The label automatically issued)		0.0 0 0	1.0 0 0	2.2 3	2.2 3					▼	▼
Remove the product from platter and take the label off..		0.0 0 0	0.0 0 0	2.2 3	0.0 0	▼				▼	▼
Repeat the above 3 and 4 step to weighing the next pack, until the last packed is weighed.		0.0 0 0	0.0 0 0	0.0 0	0.0 0	▼				▼	▼

For example: issue 20 labels of SMOKED SAUSAGE (Non-Weighing Item, PLU #30).

1 - ZERO 2 - NET 3 - FIX T 4 - FIX P 5 - MANUAL 6 - LABEL

OPERATION	KEYS	PT kg	Kg	\$/kg	\$	1	2	3	4	5	6
Stand-by-status.		0.0 0 0	0.0 0 0	0.0 0	0.0 0	▼				▼	▼
Enter the PLU No. of the Smoked Sausage.	[3] [0] [PLU]			2.5 0	PR-PCS					▼	▼
Prepare to issue label for non-weighing item.	[*]		LABEL	NUMBER	1					▼	▼
Enter number of labels to be printed, e.g. 20	[2][0]		LABEL	NUMBER	2 0					▼	▼
Print out the first label...	[*]		LABEL	COUNT	2 0					▼	▼
Print out the second label... *Note			LABEL	COUNT	1 9					▼	▼
.....											
Print out the last label.			LABEL	COUNT	1					▼	▼
Stand-by-status.		0.0 0 0	0.0 0 0	0.0 0	0.0 0	▼				▼	▼

Note! To cancel printing, depress C key.

4.10.2 Item Label Issue for NON-PLU Item

It is possible to print item label for Non-PLU Item at Pre-pack Mode. The Non-PLU Item will be cleared is a PLU is called up or **[C]** key is pressed.

For example: At Pre-pack Mode, enter the Price for Non-PLU item (Ex. 5.00) by numeric key.

		1 - ZERO	2 - NET	3 - FIX T	4 - FIX P	5 - PREPACK	6 - LABEL				
OPERATION	KEYS	PT kg	Kg	\$/kg	\$	1	2	3	4	5	6
At Pre-pack Mode		0.0 0 0	0.0 0 0	0.0 0	0.0 0	▼				▼	▼
Enter the unit price(Ex.5.00)	[5][0][0]	0.0 0 0	0.0 0 0	5.0 0	0.0 0	▼				▼	▼
Place the product on the platter. (e.g. 1kg) (The label automatically issued)		0.0 0 0	1.0 0 0	5.0 0	5.0 0					▼	▼
Remove the product from platter and take the label off..		0.0 0 0	0.0 0 0	2.2 3	0.0 0	▼				▼	▼
	[C]	0.0 0 0	0.0 0 0	0.0 0	0.0 0	▼				▼	▼

Note1: For Non-weight Item, just press **[*]** key to start issuing out a label and registered to PLU # 999999.

Note2: For Weighing of Non-PLU Item will be registered to PLU # 999998.

5. READ REPORT MODE

5.1 Report Factor Select

Whether to use the following report print factors depends on the type of report. Please refer to Operation Flow in Report Mode.

PRINT LIMIT

For setting the report range, Department Number, Main Group Number or PLU Number to start and finish is to be entered.

LOWER LIMIT: DEPARTMENT: No.1 - No.99

MAIN GROUP: No.1 - No.999

UPPER LIMIT: DEPARTMENT: No.1 - No.99

MAIN GROUP: No.1 - No.999

5.2 Report Type Selection

There are two ways to select the Report Type by using different keys such as:

- Preset keys that the desired Report Type is assigned to .
- By press **[X]** or [\approx][\approx]key to select the Report Type .

Enter Report Mode (“**X**” Mode) from Stand-by Status.

OPERATION	DISPLAY				REMARK
	PT	kg	\$ /kg	\$	
	0.000	0.000	0.00	0.00	Stand-by Status
[MODE][MODE]	X1.1	READ	MG	DAILY	Enter X mode.
[X]	X2.1	READ	PLU	DAILY	Press [X] key to select the Report Type.

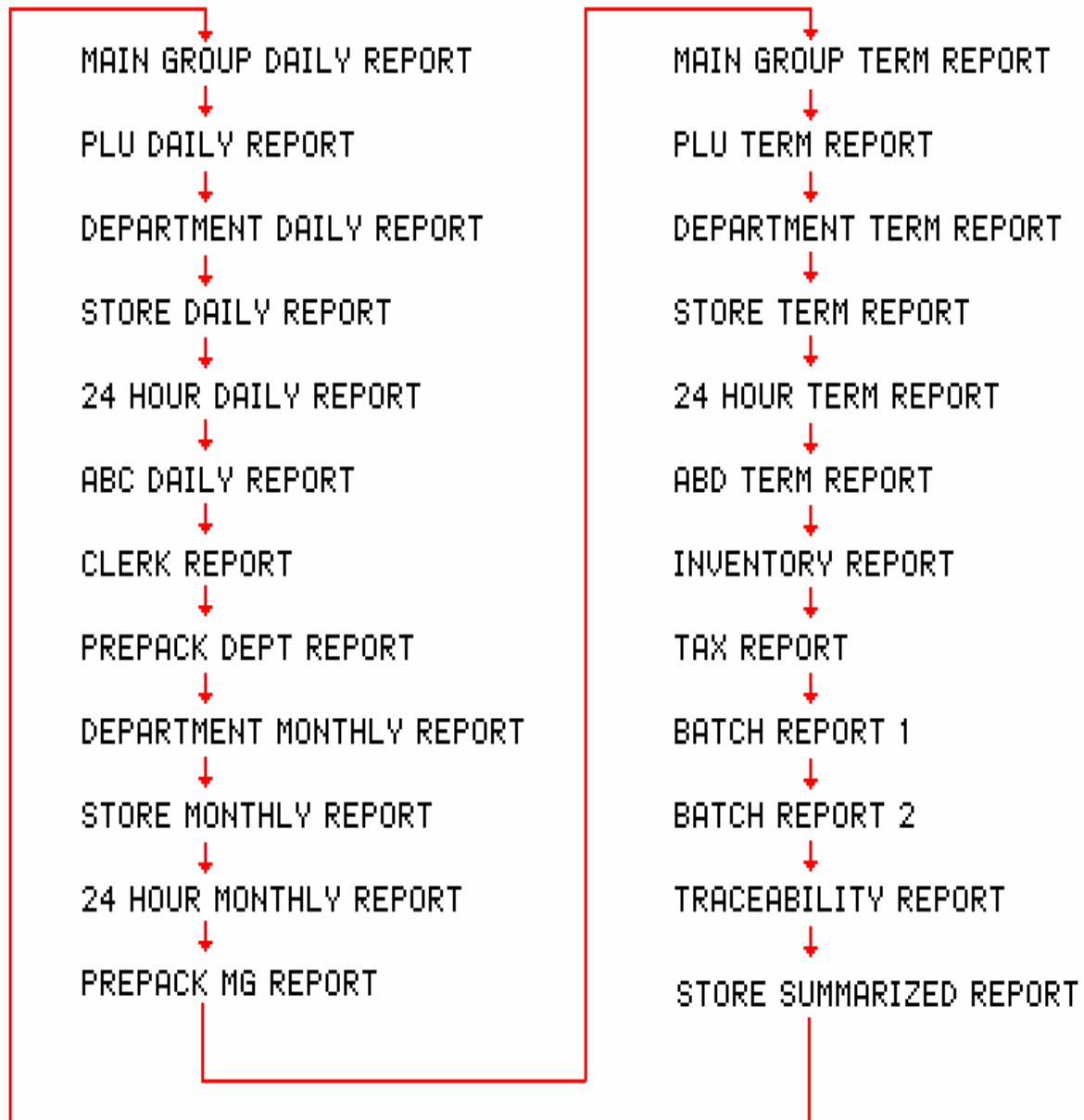

5.2.1 Main Group Report

Printing report order for MAIN GROUP Daily/Term Read Report:

For example:

- MAIN GROUP LOWER LIMIT: **3**
- MAIN GROUP UPPER LIMIT: **996**

OPERATION	DISPLAY				REMARK
	PT	kg	\$ /kg	\$	
Enter X mode	X1.1	READ	MG	DAILY	Select M.G. Daily Read Report.
[*]	X1.1		1	ST NUM	Enter starting M.G.(Ex.3)
[3][*]	X1.1		3	ED NUM	Enter ending M.G.(Ex.996)
[9][9][6][*]			- REPORT	PRINTING -	Print M.G. daily Read Report
	X1.1	READ	MGROUP	DAILY	Display back to X mode.
[↵] or [↶] or [X]	X1.4	READ	MG	TERM	Select M.G. Term Read Report.
[*]	X1.4		1	ST NUM	Enter starting M.G.(Ex.3)
[3][*]	X1.4		3	ED NUM	Enter ending M.G.(Ex.996)
[9][9][6][*]			- REPORT	PRINTING -	Print M.G. Term Read Report.
	X1.4	READ	MG	TERM	Display back to X mode.

5.2.2 PLU Report

Printing report order for PLU Daily/Term Read Report:

For example:

- PLU NUMBER LOWER LIMIT: **3**
- PLU NUMBER UPPER LIMIT: **999996**

OPERATION	DISPLAY				REMARK
	PT	kg	\$ /kg	\$	
Enter X mode	X1.1	READ	MG	DAILY	Lamp X turns on.
[↵] or [↶] or [X]	X2.1	READ	PLU	DAILY	Select PLU Daily Read Report.
[*]	X2.1		1	ST NUM	Enter starting PLU Number.(Ex.3)
[3][*]	X2.1		3	ED NUM	Enter ending PLU Number.(Ex.999996)
[9][9][9][9][9][6][*]			- REPORT	PRINTING -	Print PLU daily Read Report
	X2.1	READ	PLU	DAILY	Display back to X mode.
[↵] or [↶] or [X]	X2.4	READ	PLU	TERM	Select PLU Term Read Report.
[*]	X2.4		1	ST NUM	Enter starting PLU Number.(Ex.3)

OPERATION	DISPLAY				REMARK
	PT	kg	\$/kg	\$	
[3][*]	X2.4		3	ED NUM	Enter ending PLU Number. (Ex.999996)
[9][9][9][9][9][6][*]			- REPORT	PRINTING -	Print PLU Term Read Report t
	X2.4	READ	PLU	PERIOD	Display back to X mode.

5.2.3 Department Report

Printing report order for DEPARTMENT Daily/Term Read Report:

For example:

- DEPARTMENT LOWER LIMIT: **3**
- DEPARTMENT UPPER LIMIT: **96**

OPERATION	DISPLAY				REMARK
	PT	kg	\$/kg	\$	
Enter X mode	X1.1	READ	MG	DAILY	Lamp X turns on.
[↵] or [↶] or [X]	X3.1	READ	DEPT	DAILY	Select Dept. Daily Read Report.
[*]	X3.1		1	ST NUM	Enter starting Dept. Number.(Ex.3)
[3][*]	X3.1		3	ED NUM	Enter ending Dept. Number.(Ex.96)
[9][6][*]			- REPORT	PRINTING -	Print Dept. daily Read Report.
	X3.1	READ	DEPT	DAILY	Display back to X mode.
[↵] or [↶] or [X]	X3.4	READ	DEPT	TERM	Select Dept. Term Read Report.
[*]	X3.4		1	ST NUM	Enter starting Dept. Number.(Ex.3)
[3][*]	X3.4		3	ED NUM	Enter ending Dept. Number.(Ex.96)
[9][6][*]			- REPORT	PRINTING -	Print Dept. Term Read Report.
	X3.4	READ	DEPT	TERM	Display back to X mode.

5.2.4 Sales Report

Printing report order for SALES Daily/Term Read Report:

OPERATION	DISPLAY				REMARK
	PT	kg	\$ /kg	\$	
Enter X mode	X1.1	READ	MG	DAILY	Lamp X turns on.
[↵] or [↶] or [X]	X4.1	READ	SALES	DAILY	Select Sales Daily Read Report.
[*]			- REPORT	PRINTING -	Print Sales daily Read Report.
	X4.1	READ	SALES	DAILY	Display back to X mode.
[↵] or [↶] or [X]	X4.4	READ	SALES	TERM	Select Sales Term Read Report.
[*]			- REPORT	PRINTING -	Print Sales Term Read Report.
	X3.4	READ	DEPT	TERM	Display back to X mode.

5.2.5 24Hour Report

On 24 Hour Report, Sales transaction data can be printed on 24-HOUR Daily/Term Read Report

If you want to stop printing, press **[FEED]** key.

OPERATION	DISPLAY				REMARK
	PT	kg	\$ /kg	\$	
Enter X mode	X1.1	READ	MG	DAILY	Lamp X turns on.
[↵] or [↶] or [X]	X5.1	READ	24 HOUR	DAILY	Select 24 HOUR Daily Read Report.
[*]			- REPORT	PRINTING -	Print 24-HOUR Daily Read Report.
	X5.1	READ	24 HOUR	DAILY	Display back to X mode.
[↵] or [↶] or [X]	X5.4	READ	24 HOUR	TERM	Select 24-HOUR Term Read Report.
[*]			- REPORT	PRINTING -	Print 24-HOUR Term Read Report.
	X5.4	READ	24 HOUR	TERM	Display back to X mode.

5.2.6 ABC Report

ABC Report is used to check the sales situation of PLUs. The share of PLUs against total sales price are printed on ABC Analysis Report by descending order. The printed shares by descending order are divided into 3 ranks: A rank, B rank and C rank.

- 1) **Rank A** includes PLUs whose accumulated share is less than 75%.

*Even if the accumulated share exceeds 75%, the last PLUs will be included in **Rank A**.

- 2) **Rank B** includes PLUs whose accumulated share is between 75% ~ 95%.

*Even if the accumulated share exceeds 95%, the last PLUs will be included in **Rank B**.

3) **Rank C** includes PLUs whose accumulated share is between 95% ~ 100%.

*Even if the accumulated share exceeds 95%, the last PLUs will be included in **Rank B**.

For example: Printing report order for ABC Daily/Term Read Report:

- PLU NUMBER LOWER LIMIT: **1**
- PLU NUMBER UPPER LIMIT: **999**

OPERATION	DISPLAY				REMARK
	PT	kg	\$ /kg	\$	
Enter X mode	X1.1	READ	MG	DAILY	Lamp X turns on.
[\curvearrowright] or [\curvearrowleft] or [X]	X6.1	READ	ABC	DAILY	Select ABC Daily Read Report.
[*]	X6.1		1	ST NUM	Enter starting PLU NO.(Ex.1)
[1][*]	X6.1		2	ED NUM	Enter ending PLU NO.(Ex.999)
[9][9][9][*]			- REPORT	PRINTING -	Print ABC Daily Read Report.
	X6.1	READ	ABC	DAILY	Display back to X mode.
[\curvearrowright] or [\curvearrowleft] or [X]	X6.4	READ	ABC	TERM	Select ABC Term Read Report.
[*]	X6.4		1	ST NUM	Enter starting PLU NO.(Ex.1)
[1][*]	X6.4		1	ED NUM	Enter ending PLU NO.(Ex.999)
[9][9][*]			- REPORT	PRINTING -	Print ABC Term Read Report.
	X6.4	READ	ABC	TERM	Display back to X mode.

5.2.7 Clerk Report

Clerk report is used to print out the total data such as total prices, total quantity and so on by every Clerk.

For example: Printing report order for CLERK Daily Read Report:

- CLERK NUMBER LOWER LIMIT: **1**
- CLERK NUMBER UPPER LIMIT: **4**

OPERATION	DISPLAY				REMARK
	PT	kg	\$ /kg	\$	
Enter X mode	X1.1	READ	MG	DAILY	Lamp X turns on.
[\curvearrowright] or [\curvearrowleft] or [X]	X7.1	READ	CLERK	DAILY	Select Clerk Daily Read Report.
[*]	X7.1		1	ST NUM	Enter starting CLERK NO.(Ex.1)
[1][*]	X7.1		1	ED NUM	Enter ending CLERK NO.(Ex.4)
[4][*]			- REPORT	PRINTING -	Print Vender Daily Read Report t
	X7.1	READ	CLERK	DAILY	Display back to X mode.

5.2.8 Pre-pack Report

On Pre-pack Report, Total data of Prepack labels (Such as total price, total quantity, etc) can be printed on PREPACK DEPARTMENT REPORT or PREPACK MAIN GROUP REPORT.

For example: Printing report order for PREPACK DEPARTMENT/ MAIN GROUP REPORT:

- DEPARTMENT LOWER LIMIT: **1**
- DEPARTMENT UPPER LIMIT: **99**
- MAIN GROUP LOWER LIMIT: **1**
- MAIN GROUP UPPER LIMIT: **999**

OPERATION	DISPLAY				REMARK
	PT	kg	\$ /kg	\$	
Enter X mode	X1.1	READ	MG	DAILY	Lamp X turns on.
[\curvearrowright] or [\curvearrowleft] or [X]	X8.1	READ	PPK DEPT	DAILY	Select Pre-pack Department Daily Read Report.
[*]	X8.1	DEPT	1	ST NUM	Enter starting Dept. Number.(Ex.1)
[1][*]	X8.1	DEPT	1	ED NUM	Enter ending Dept. Number.(Ex.99)
[9][9][*]			- REPORT	PRINTING -	Print Pre-pack Department Daily Read Report.
	X8.1	READ	PPK DEPT	DAILY	Display back to X mode.
[\curvearrowright] or [\curvearrowleft] or [X]	X8.2	READ	PPK MG	DAILY	Select Pre-pack Main Group Daily Read Report.
[*]	X8.2	DEPT	1	ST NUM	Enter starting Dept. Number.(Ex.1)
[1][*]	X8.2	DEPT	1	ED NUM	Enter ending Dept. Number.(Ex.999)
[9][9][9][*]			- REPORT	PRINTING -	Print Pre-pack Main Group Daily Read Report
	X8.2	READ	PPK MG	DAILY	Display back to X mode.

5.2.9 Tax Report

Tax report is used to print out the Tax total data such as Tax Type, Tax rate, Amount Including Tax, Amount Excluding Tax, Tax Amount and so on by every Tax Number.

OPERATION	DISPLAY				REMARK
	PT	kg	\$ /kg	\$	
Enter X mode	X1.1	READ	MG	DAILY	Lamp X turns on.
[\approx] or [\approx] or [X]	X9.4		READ	TAX	Select Tax Daily Read Report.
[*]	X9.4		1	ST NUM	Enter starting Tax Number.(Ex.1)
[1][*]	X9.4		1	ED NUM	Enter ending Tax Number.(Ex.3)
[3][*]			- REPORT	PRINTING -	Print Tax daily Read Report.
	X9.4		READ	TAX	Display back to X mode.

5.2.10 Store Summarized Report

OPERATION	DISPLAY				REMARK
	PT	kg	\$ /kg	\$	
Enter X mode	X1.1	READ	MG	DAILY	Lamp X turns on.
[\approx] or [\approx] or [X]	X4.3	READ	STORE	SUMMARY	Select Store Summarized Daily Read Report.
[*]			- REPORT	PRINTING -	Print Store Summarized Daily Read Report.
	X4.3	READ	STORE	SUMMARY	Display back to X mode.

6. RESET REPORT MODE

6.1. Reset Report

6.1.1 Sales Daily / Monthly/Term Reset Report

OPERATION	DISPLAY				REMARK
	PT	kg	\$ /kg	\$	
Enter Z mode	Z1.0	RESET	SALES	DAILY	Lamp Z turns on.
[*]	RESET	REPORT	?	Y-C N-T	Enter Reset mode. [C] for Yes,[T] for No.
[C]	Z1.0	RESET	SALES	DAILY	Display back to Z mode.
[↵] or [↶] or [X]	Z2.0	RESET	SALES	MONTHLY	Select Sales Monthly Reset Report.
[*]	RESET	REPORT	?	Y-C N-T	Enter Reset mode. [C] for Yes,[T] for No.
[C]	Z2.0	RESET	SALES	MONTHLY	Display back to Z mode.
[↵] or [↶] or [X]	Z3.0	RESET	SALES	TERM	Select Sales Term Reset Report.
[*]	RESET	REPORT	?	Y-C N-T	Enter Reset mode. [C] for Yes,[T] for No.
[C]	Z3.0	RESET	SALES	TERM	Display back to Z mode.